

151

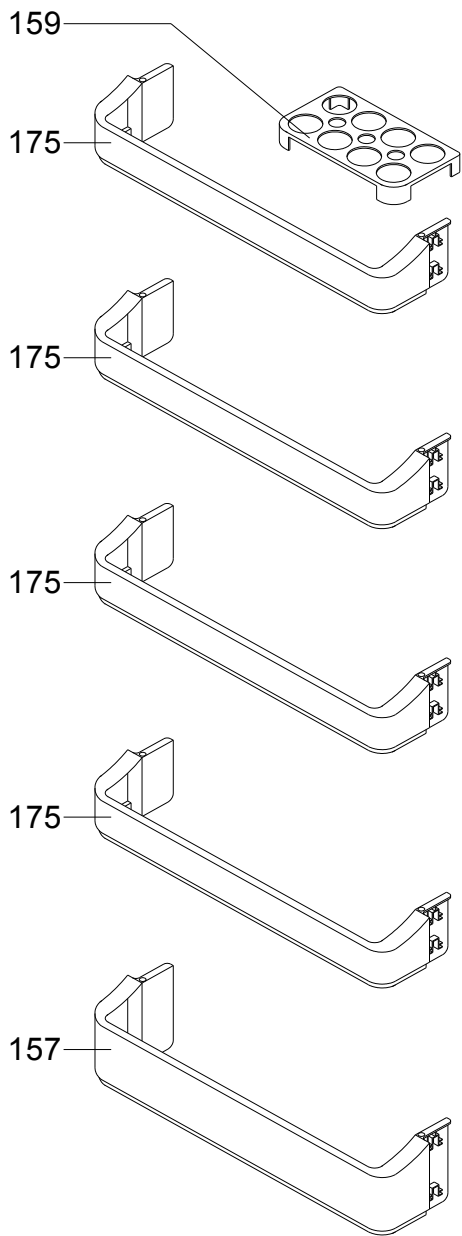

11

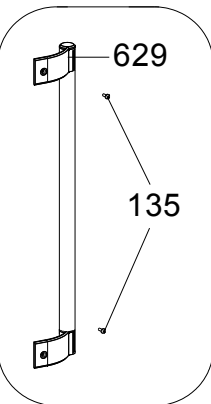
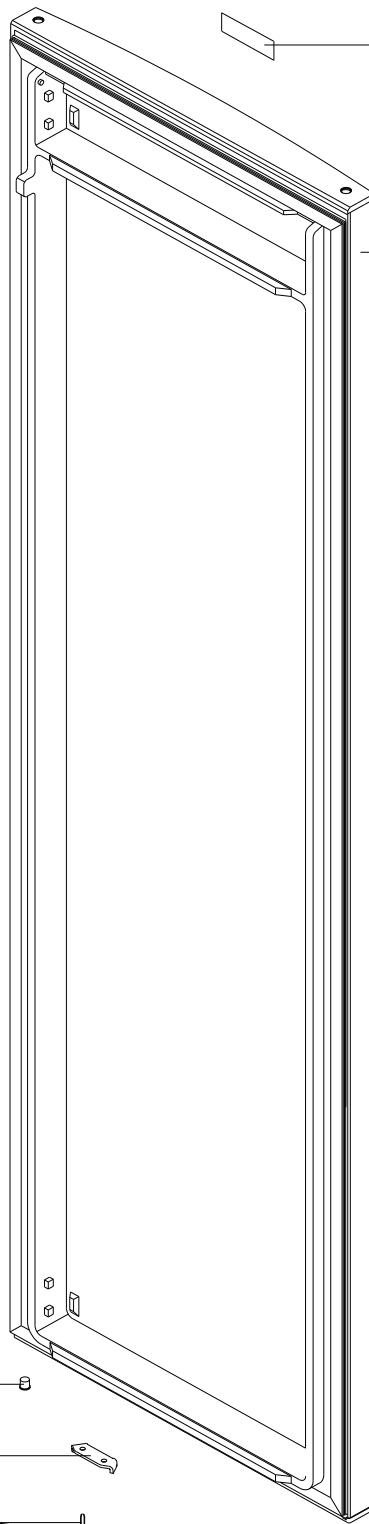

606

