

431

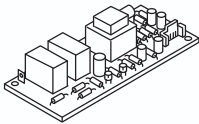

437

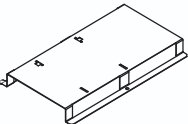

408

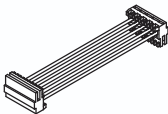

429



430

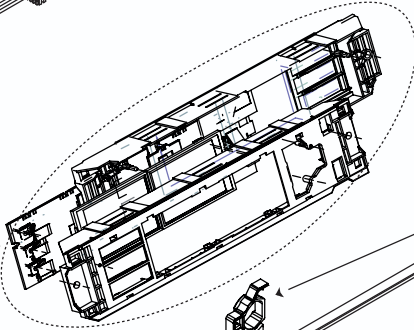

401

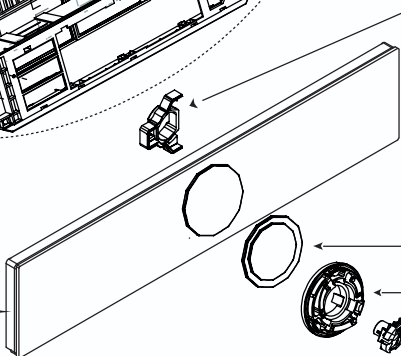

402

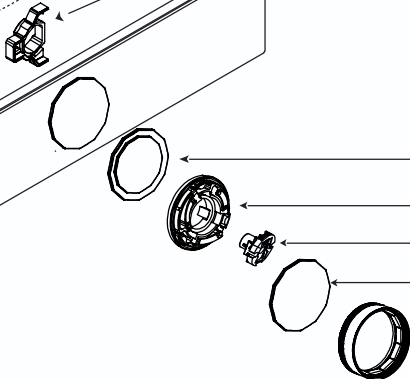

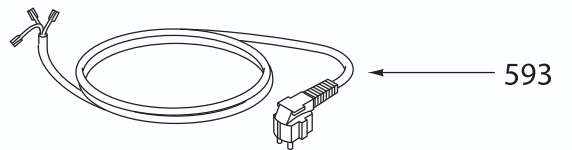
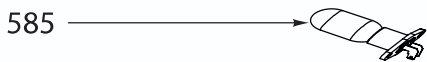
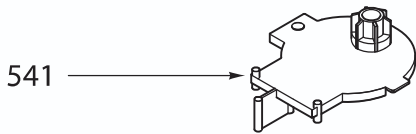
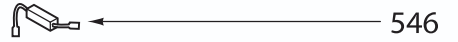
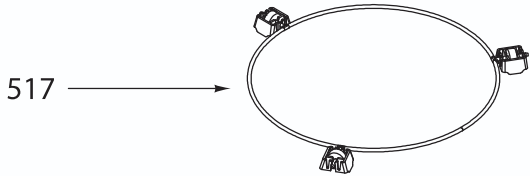
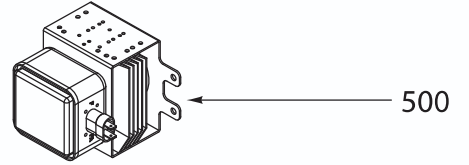
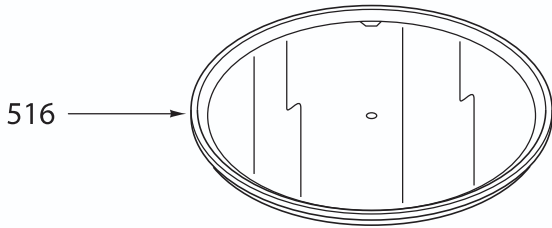
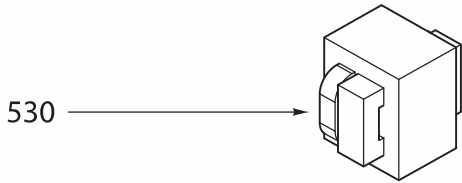

F5-797

