

TANK ÜST TANK UP

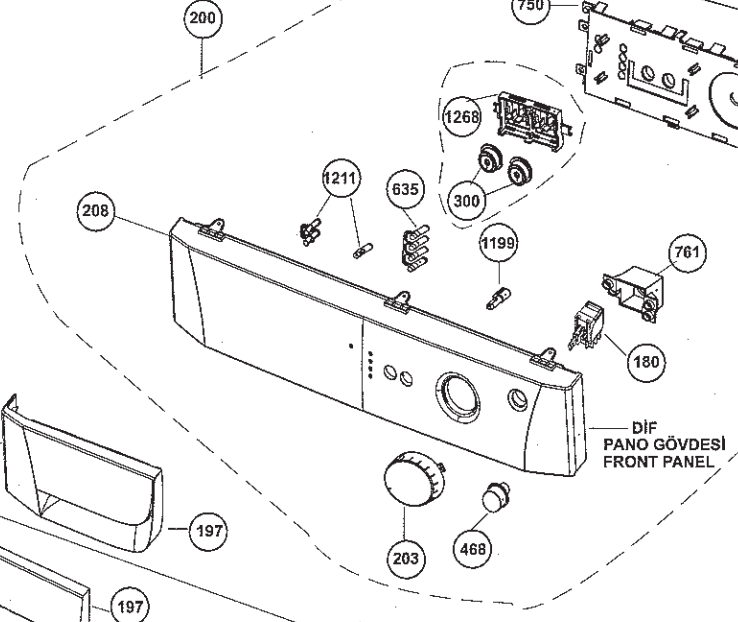
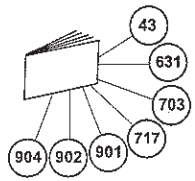
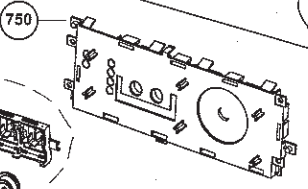
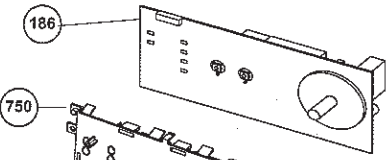
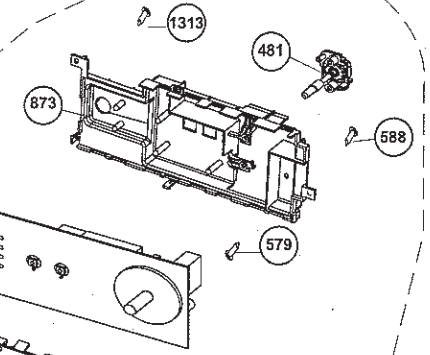

DİF PANO GÖVDESİ FRONT PANEL

DİF ÇEKMECE GÖVDESİ DRAWER PANEL

TANK ÜST TANK UP

PL0-PL0A ÇEKMECE GÖVDESİ DRAWER PANEL

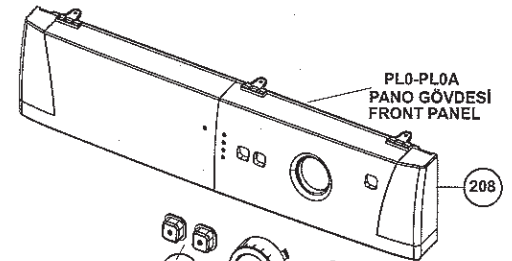
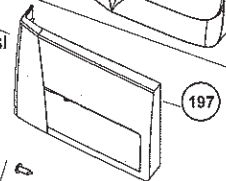
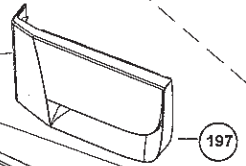

PL0A PROG.DÜĞ.GR. KNOB ASSY.

PL0 PROG.DÜĞ.GR. KNOB ASSY.

