

**GASARMATUR
GAS EQUIPMENT**

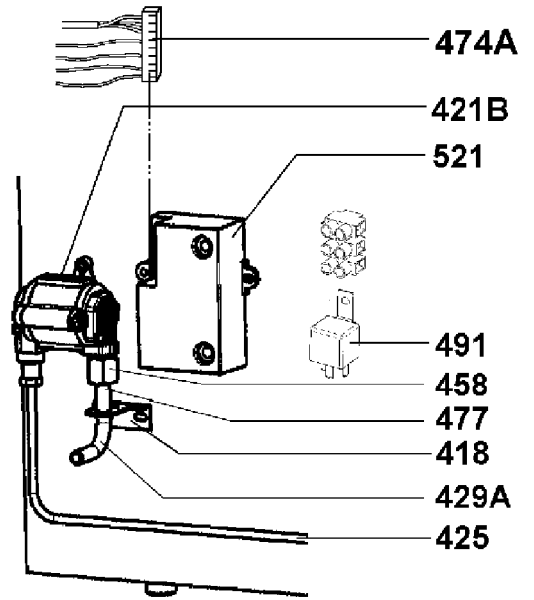

**ELEKTROARMATUR
ELECTRO EQUIPMENT**

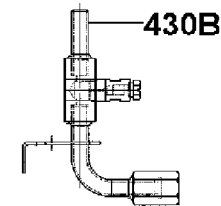
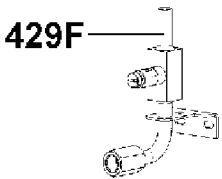
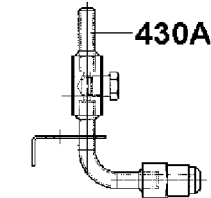
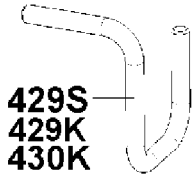
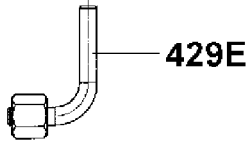
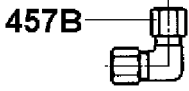
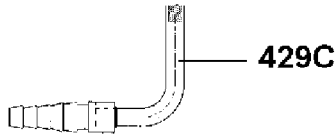
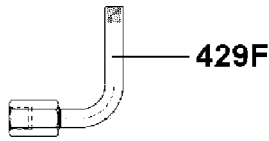
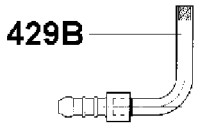
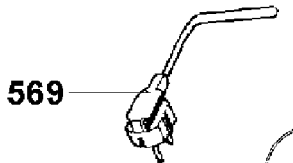

493

446

515A

486C

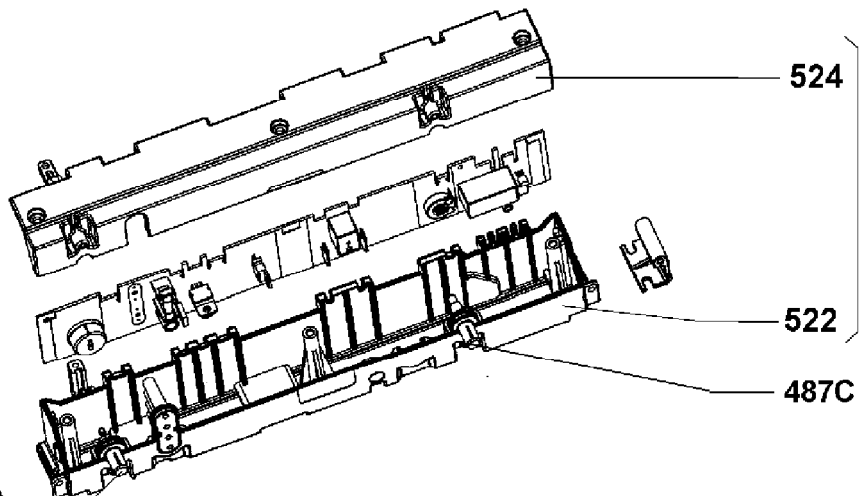

401

