

99

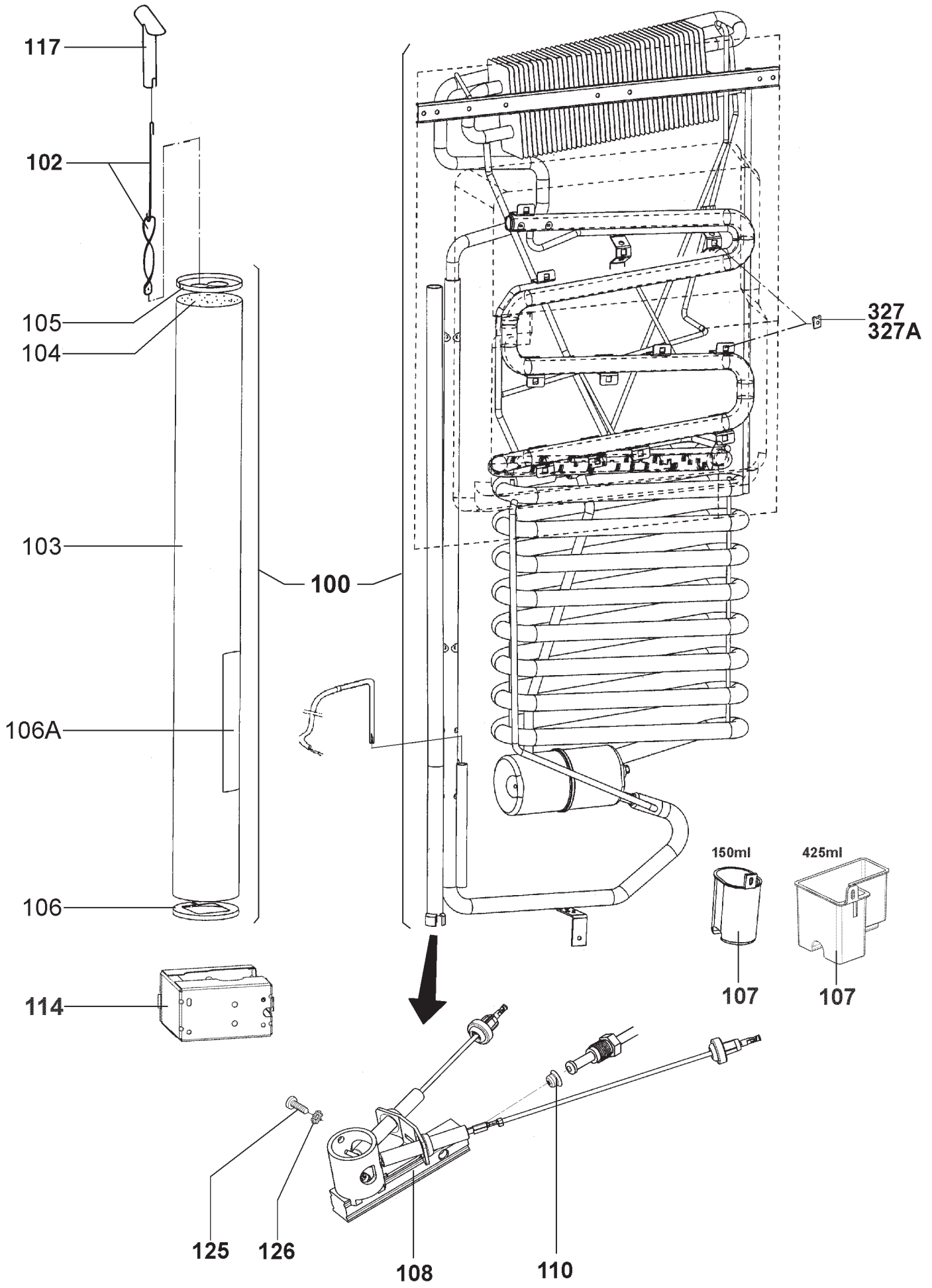

**GASARMATUR
GAS EQUIPMENT**

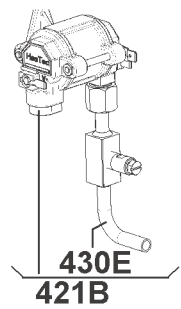
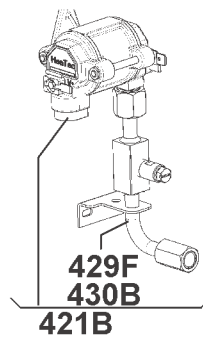
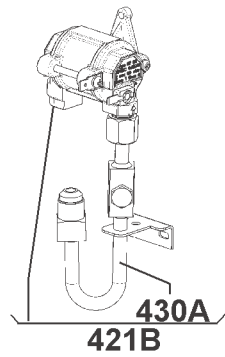
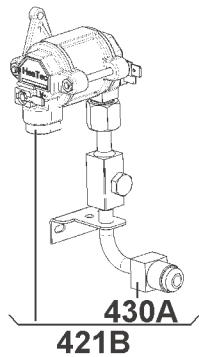
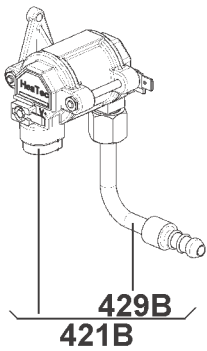
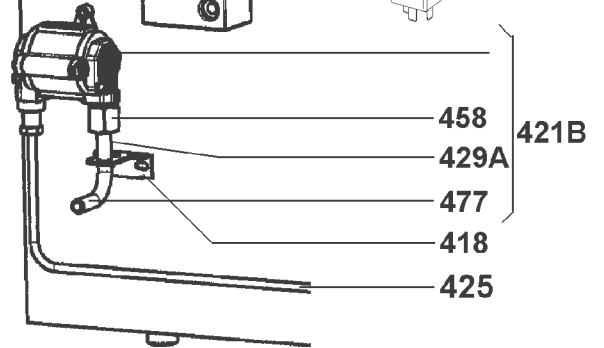
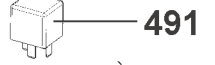
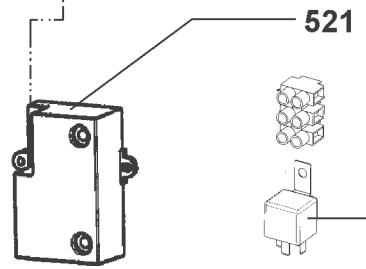
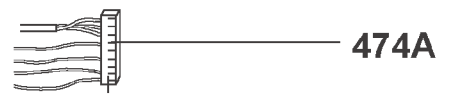
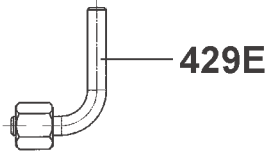
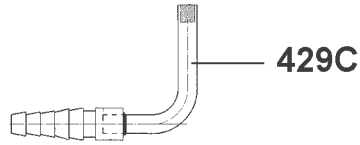
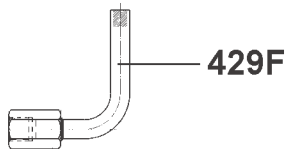
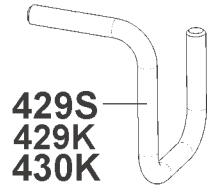

**ELEKTROARMATUR
ELECTRO EQUIPMENT**

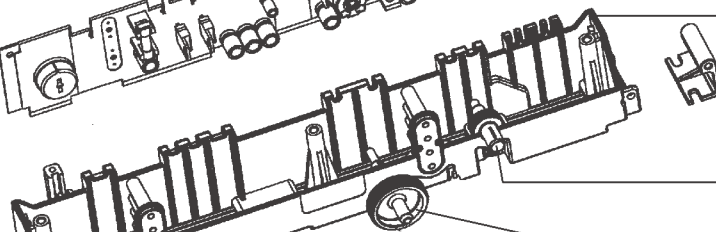
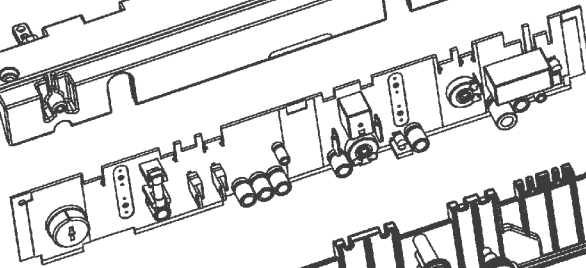
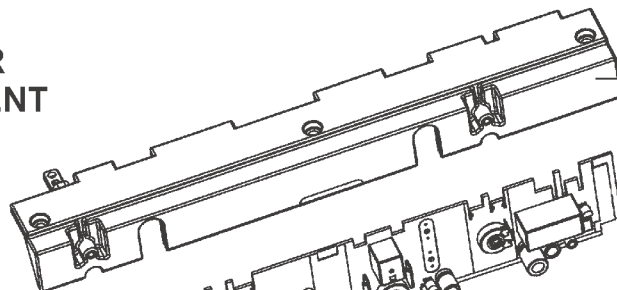
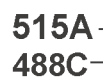
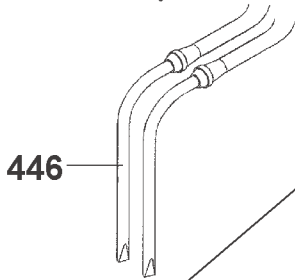
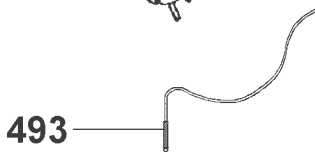
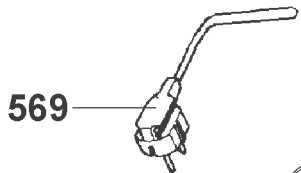

401

