

2004

2005

2001

2002

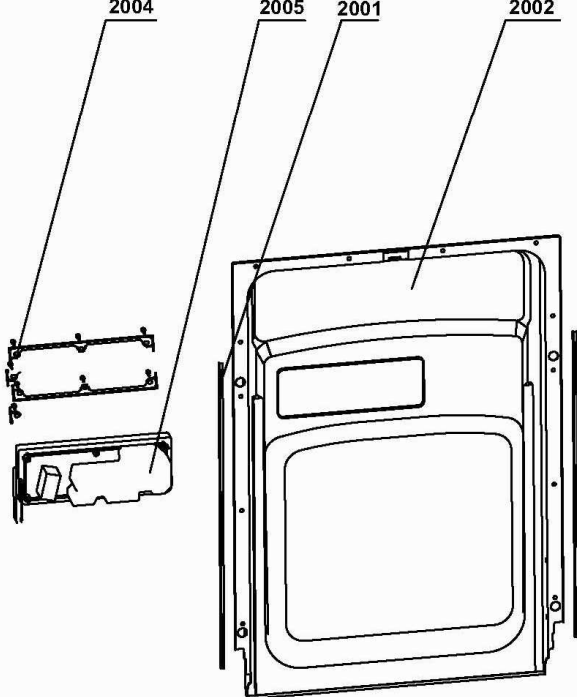

2950

2951

2035

2080

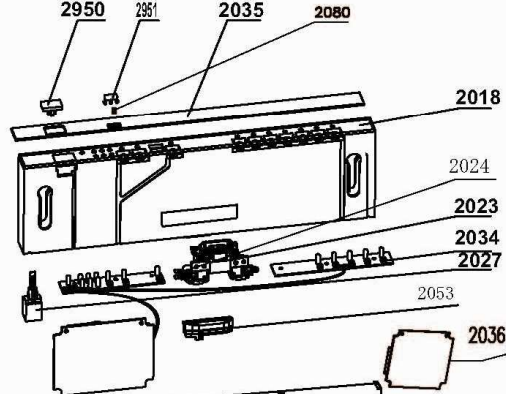

2018

2024

2023

2034

2027

2053

2036

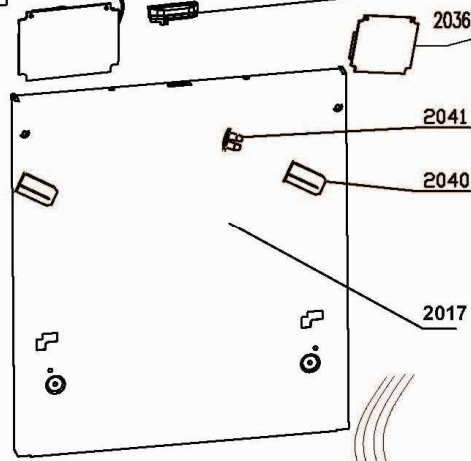

2041

2040

2017

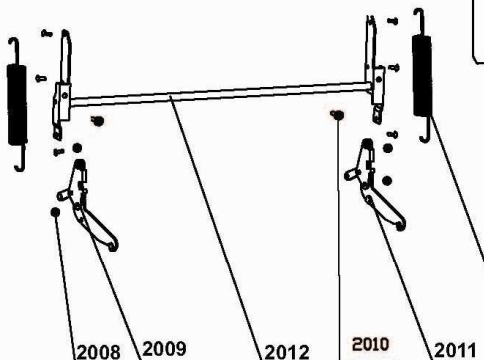

2008

2009

2012

2010

2011

2013

2006





