







106

1		ST4*14	X14	6		X1
2		ST3.5X45	X4	7		X2
3		ST3.5X25	X2	8		X2
4			X2	9		X2
5		ST3.5X16	X2	10		X2

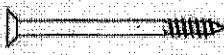
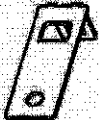
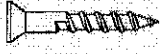



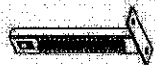
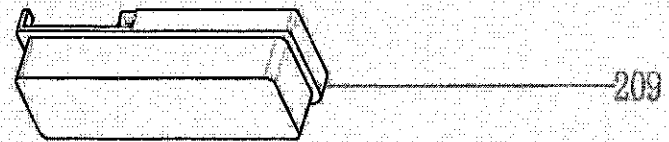
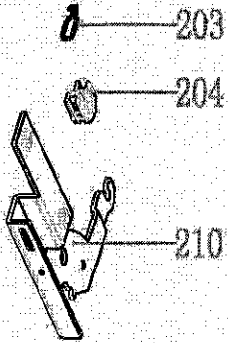
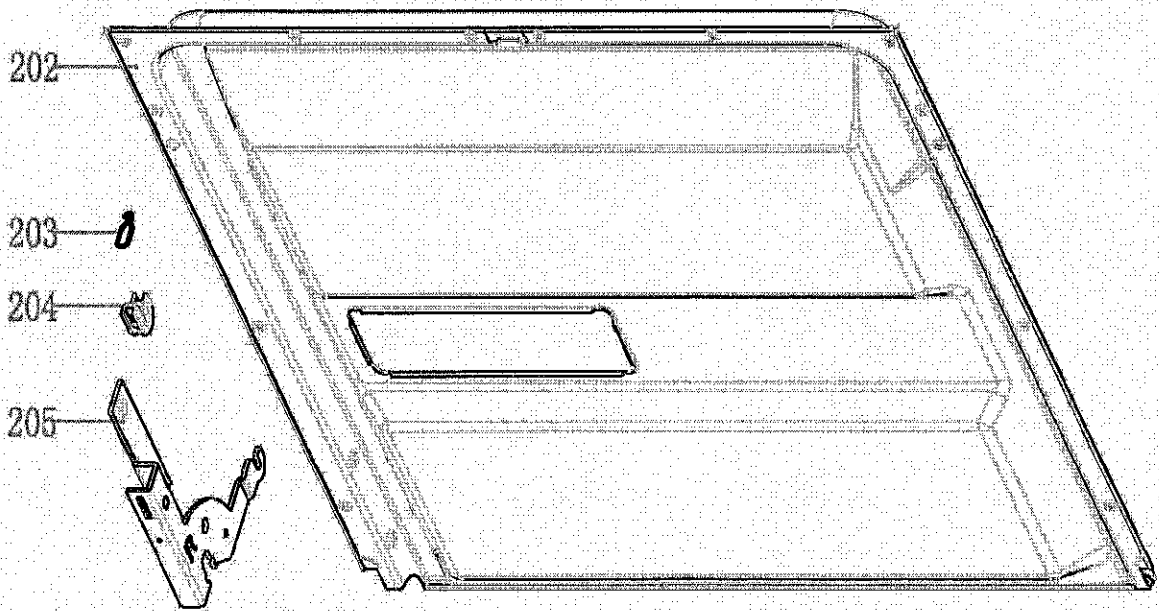
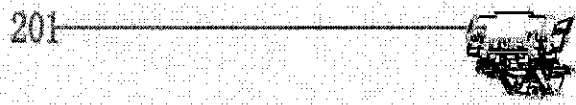
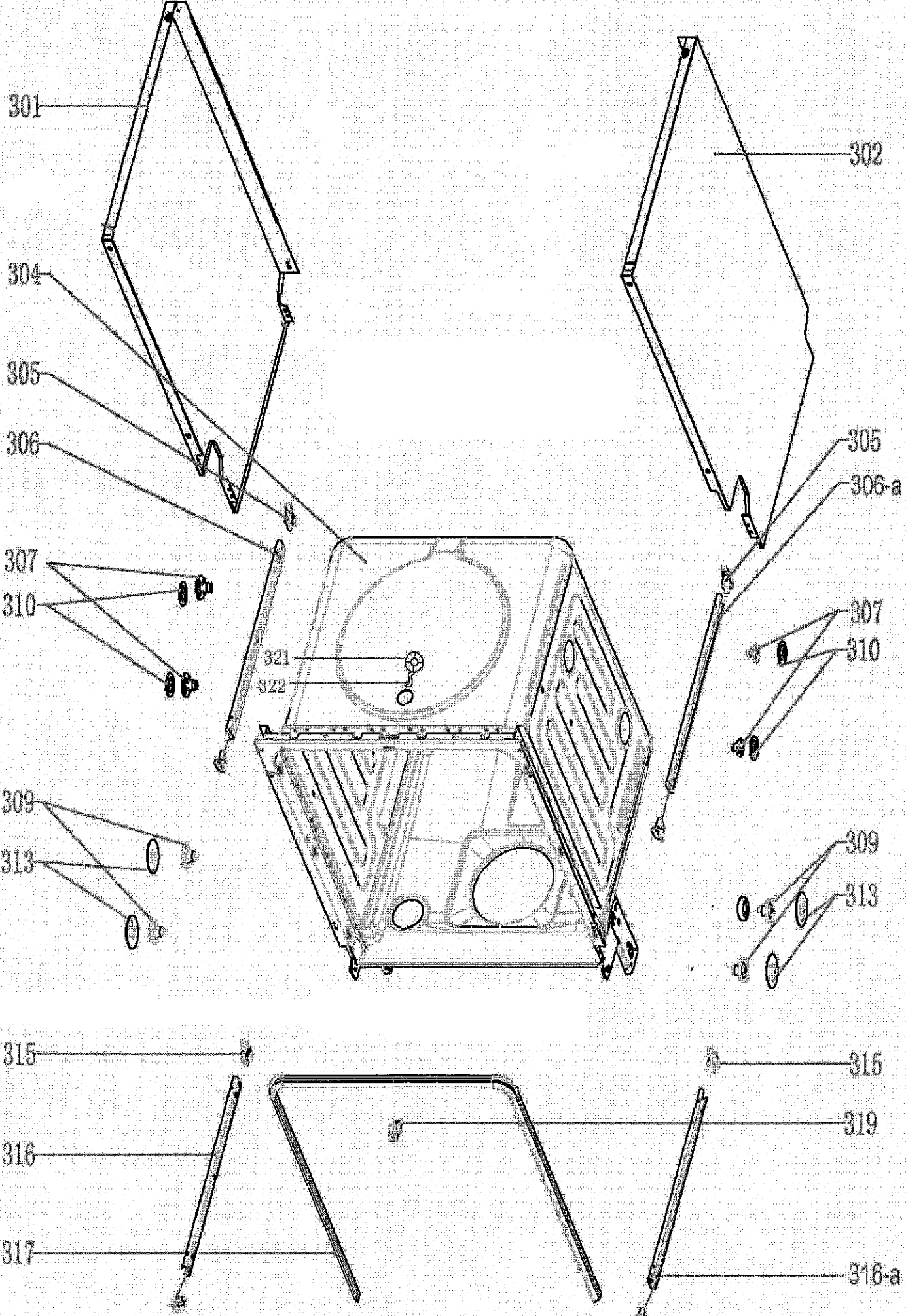
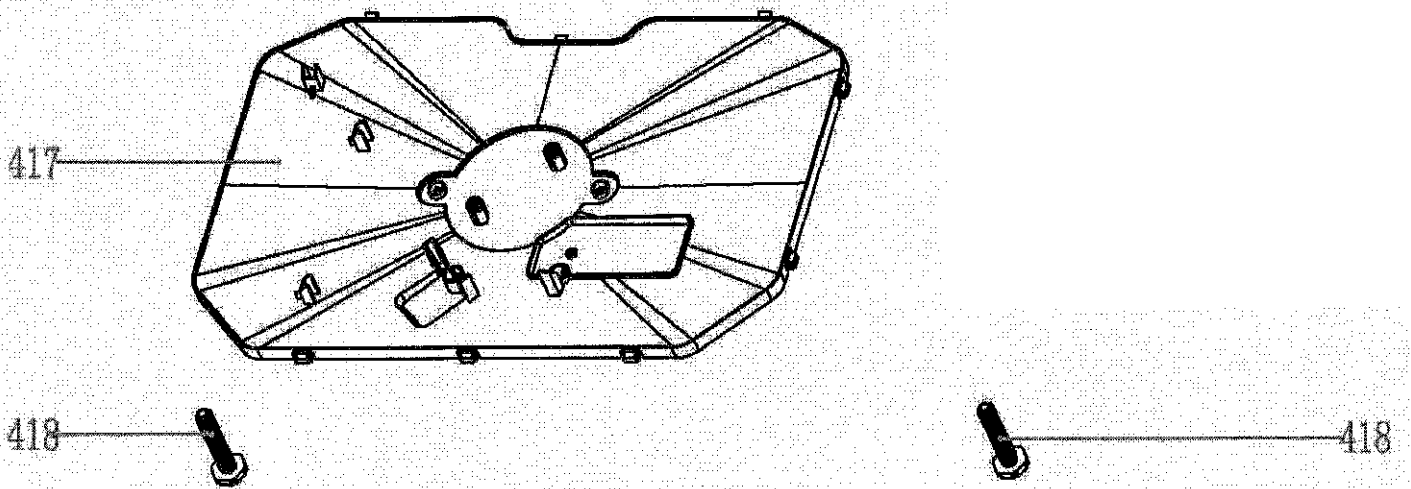
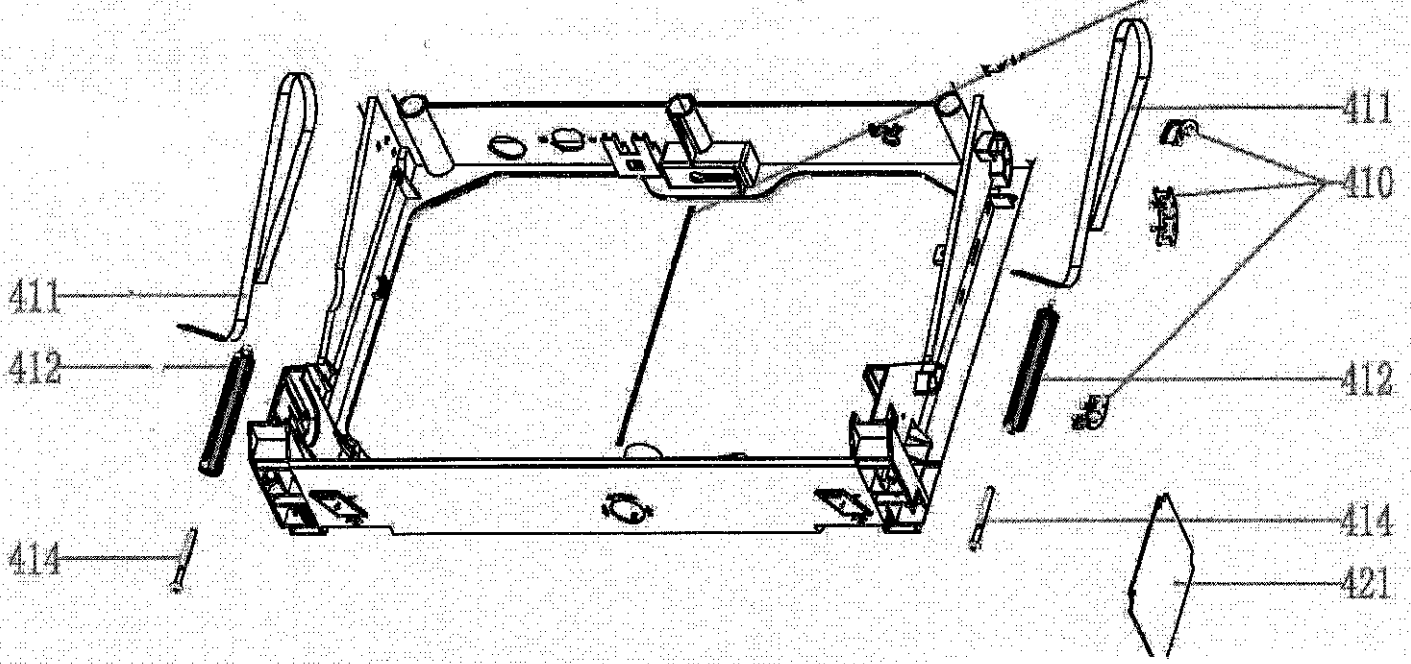
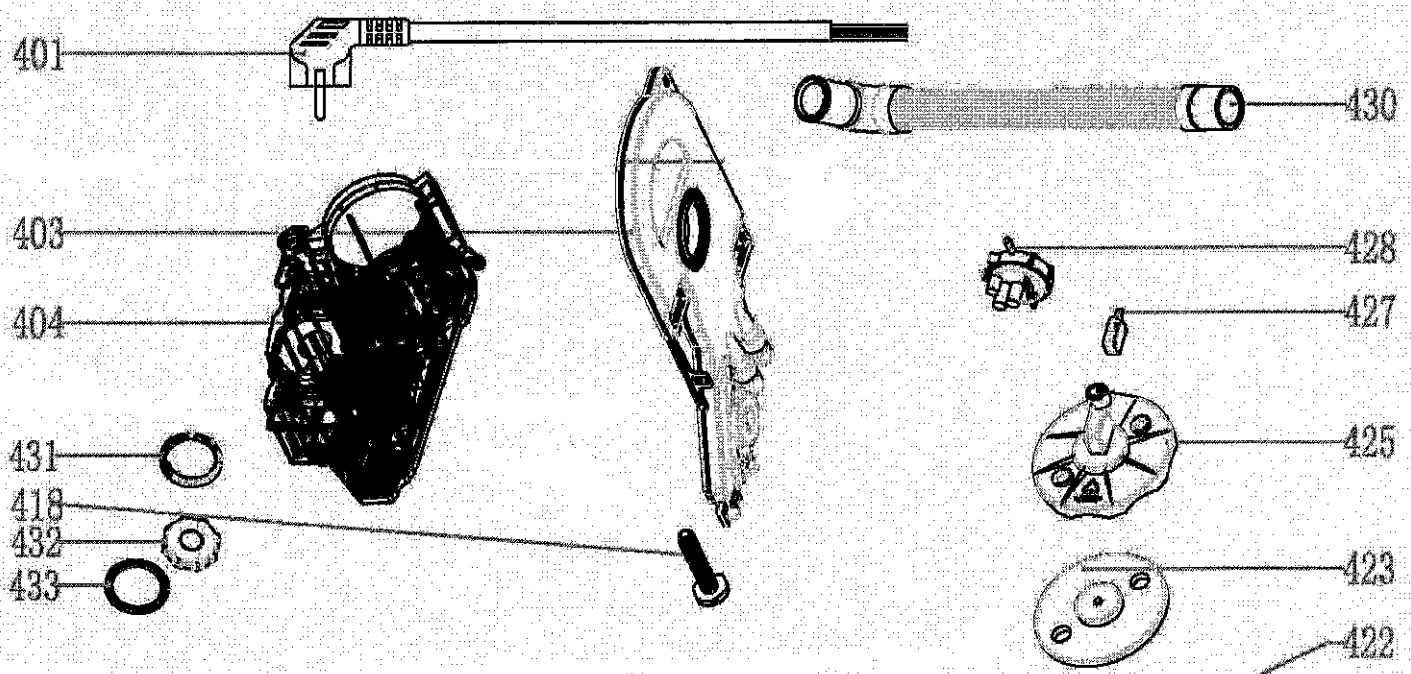

507

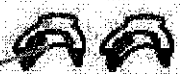
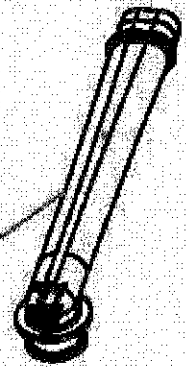

510

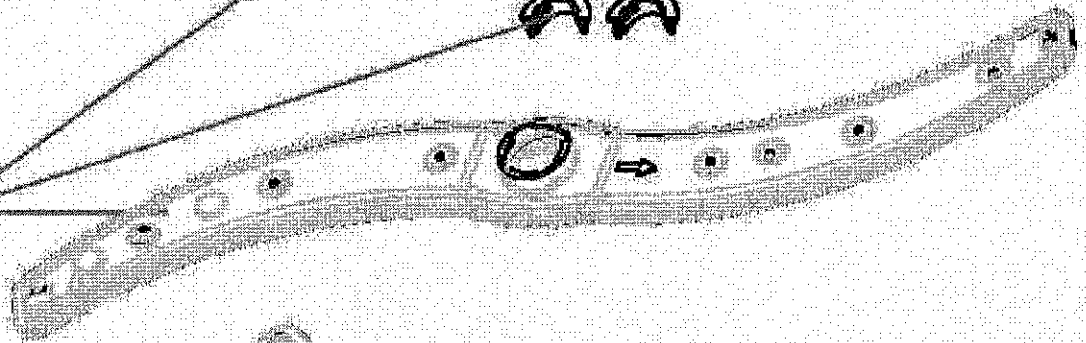

511

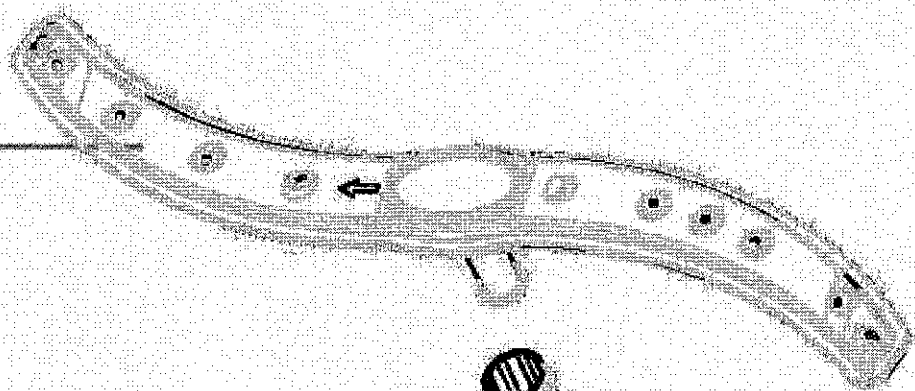

512



601

602

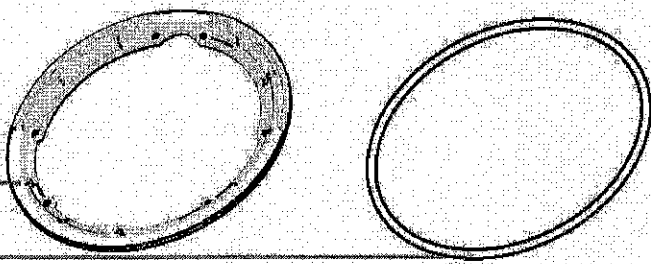

604

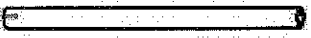

623

607



608

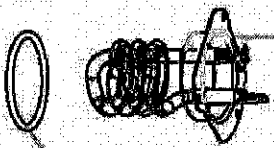
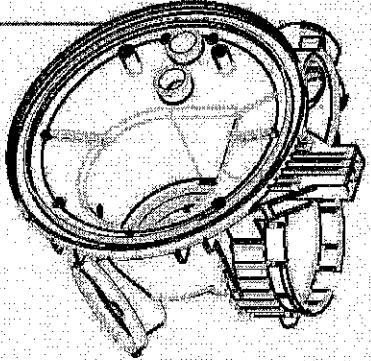

621

620

619

618

617

616

615

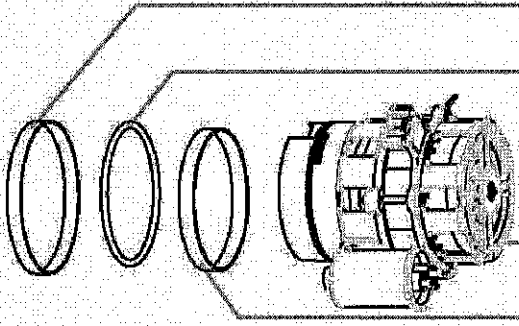

611

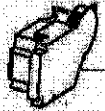
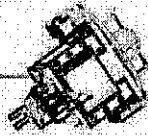

626

612

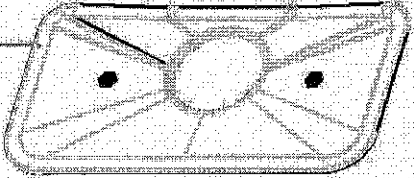

627



625

613

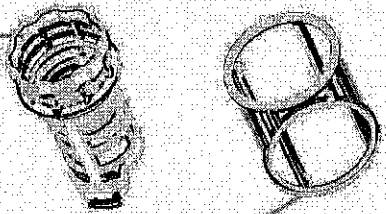

614

705

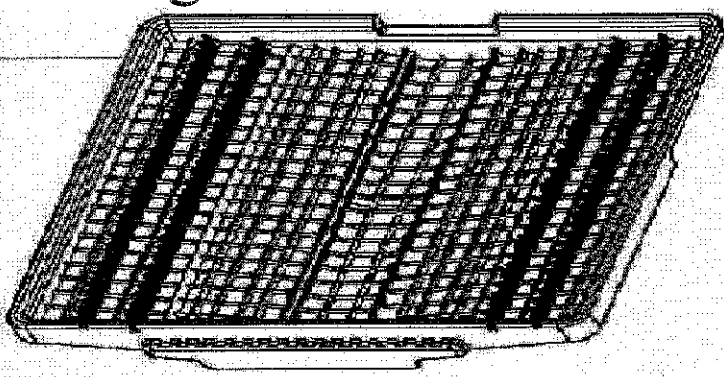

711

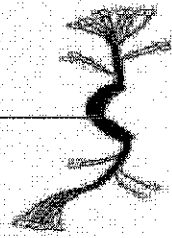

712

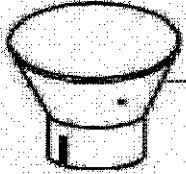

706

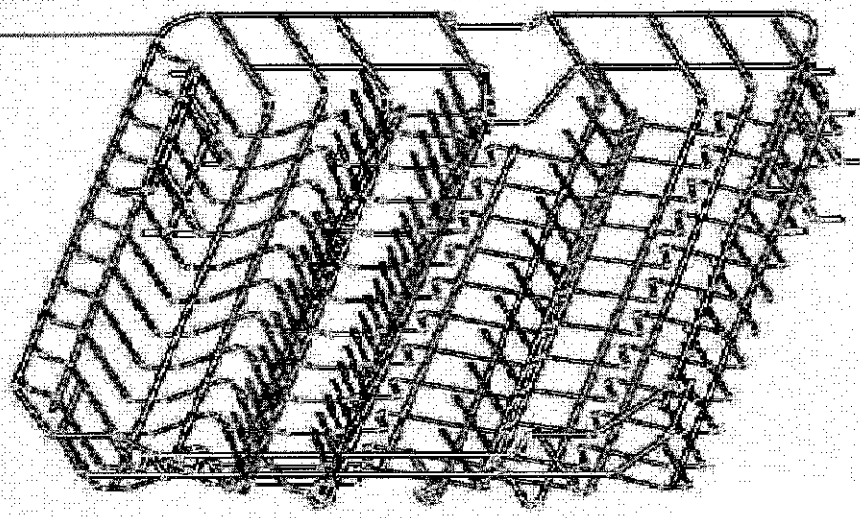

709

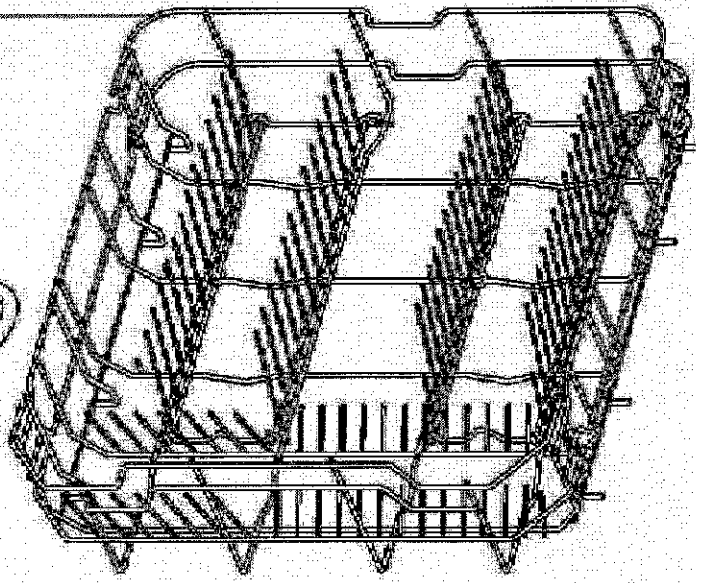

710
avec
l'électrovanne

