

274A

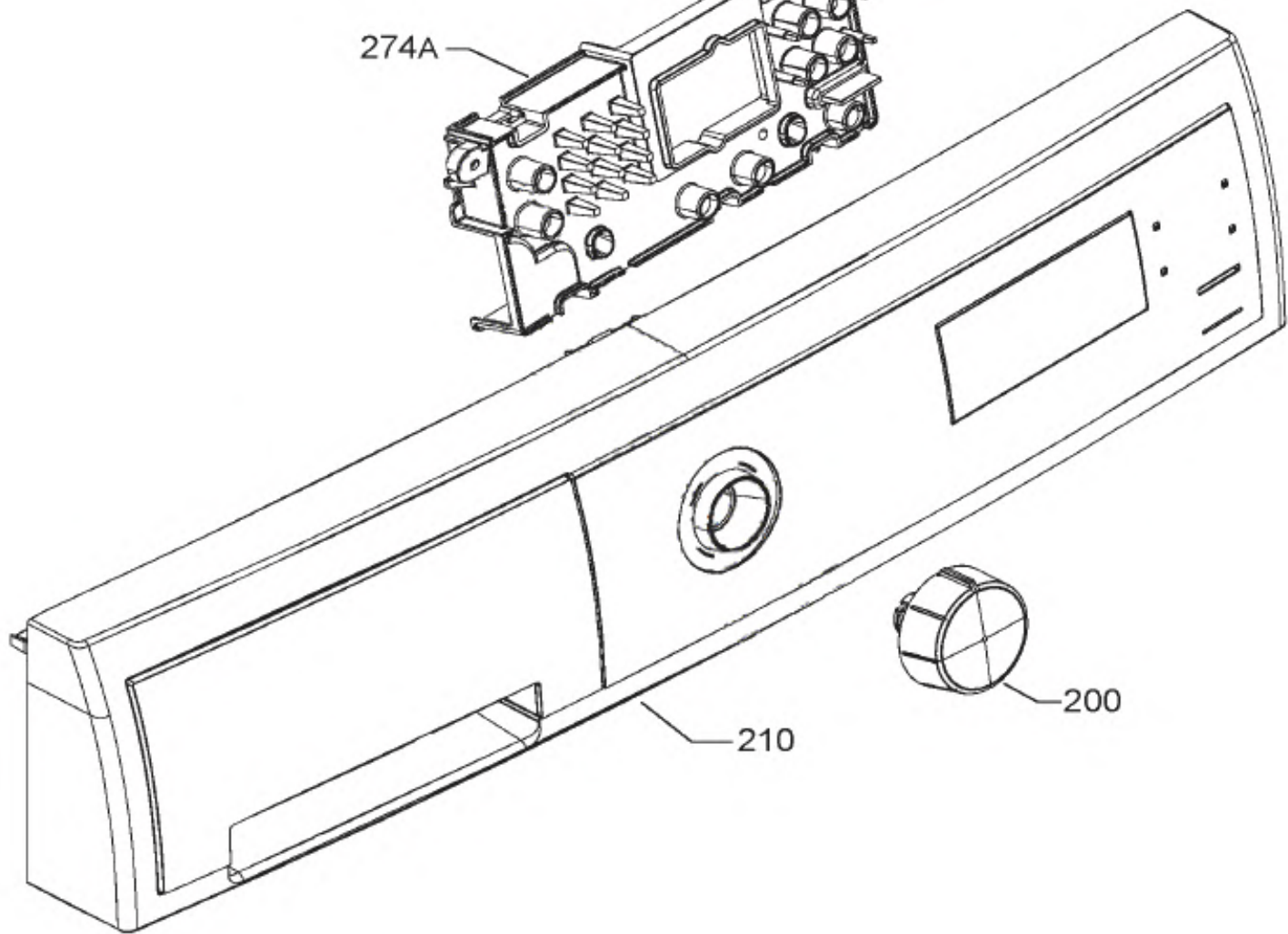

210

200

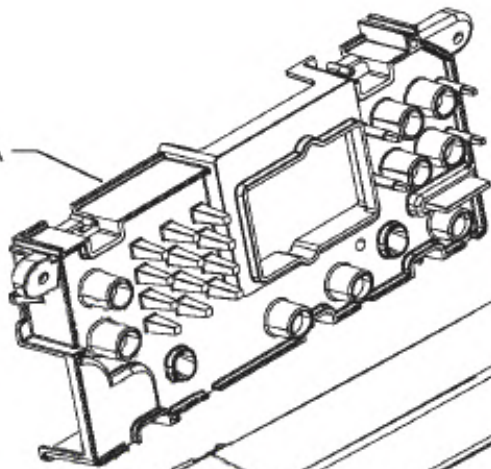