

344

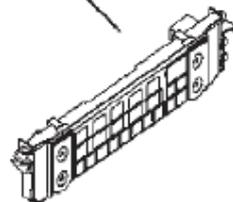

587A



118

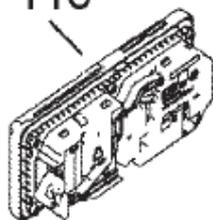

16



110B

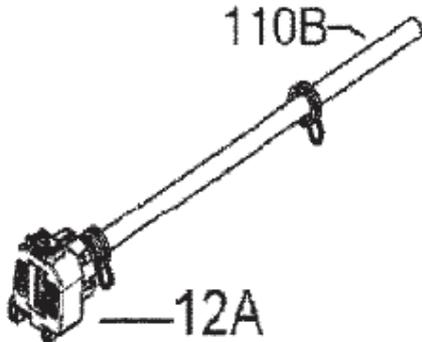

577

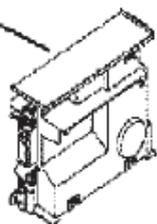

587

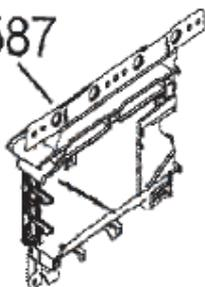

506

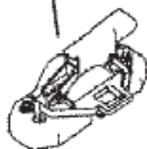

6

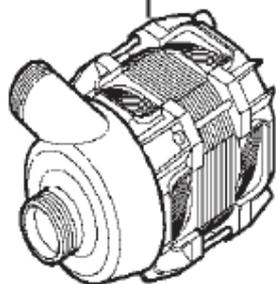

10

11



6A



48



567

