

408

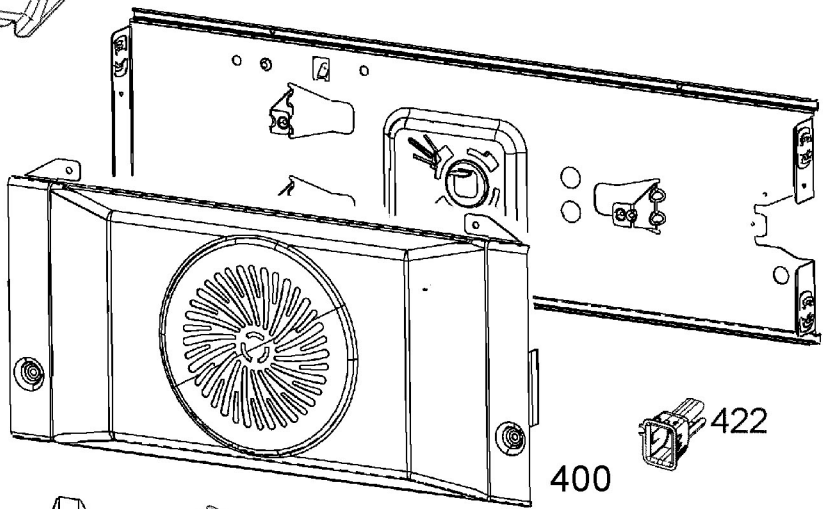

402

400

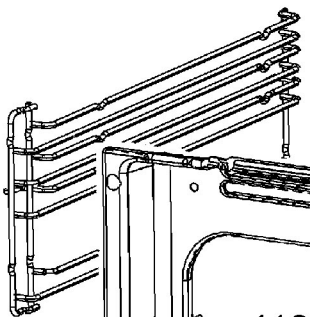

404L



420



422

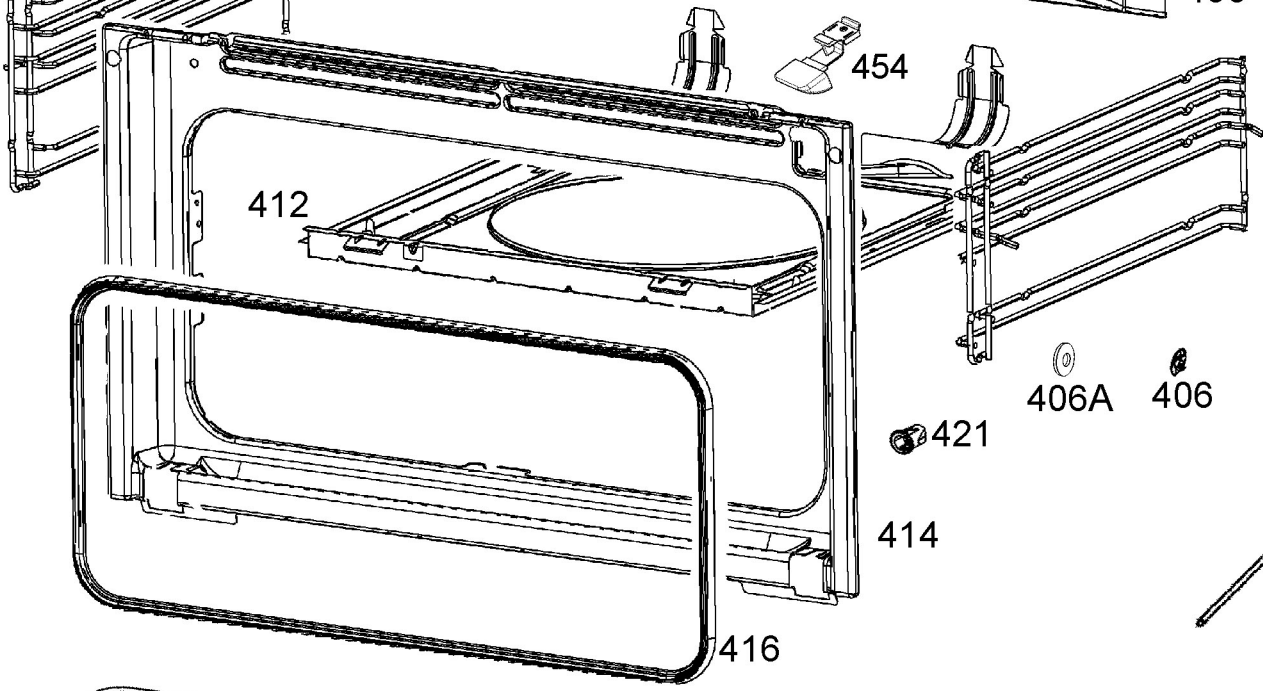

412

454

404R

406A

406

421

414

416

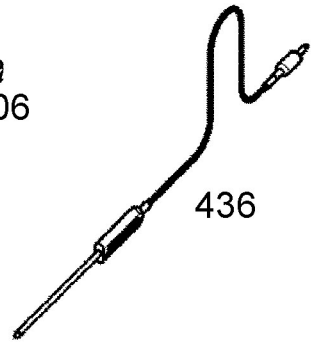

436

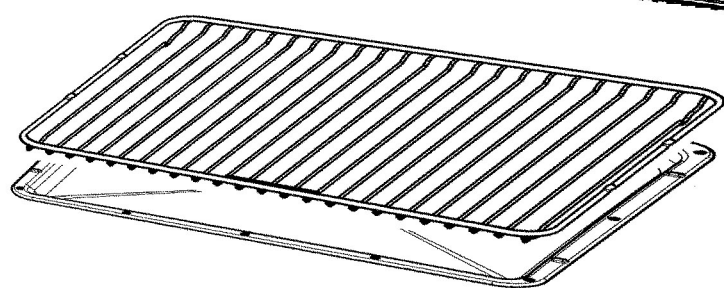

430

432B

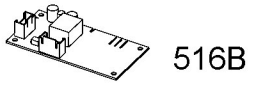

516B

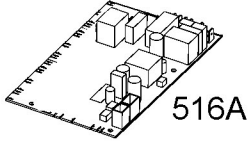

516A

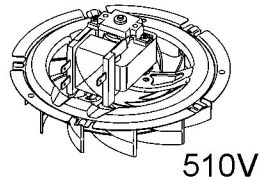

510V



518V



534

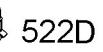
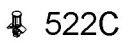

502U



506U

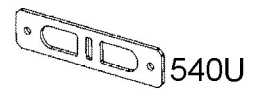

540U

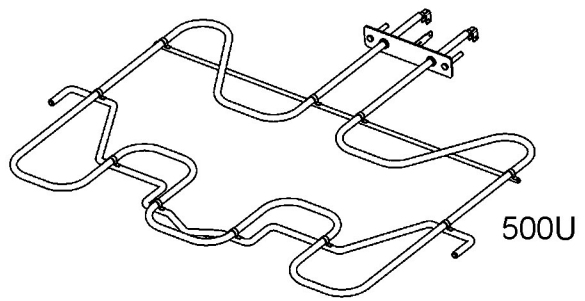

500U

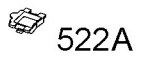

522A

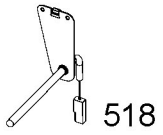

518

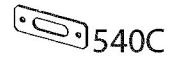

540C



540O

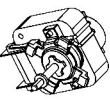
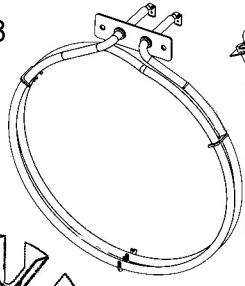

510C



518S

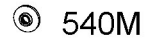

540M



522B



522

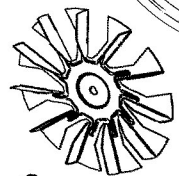

512

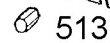

513

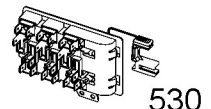

530

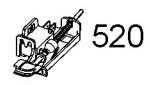

520

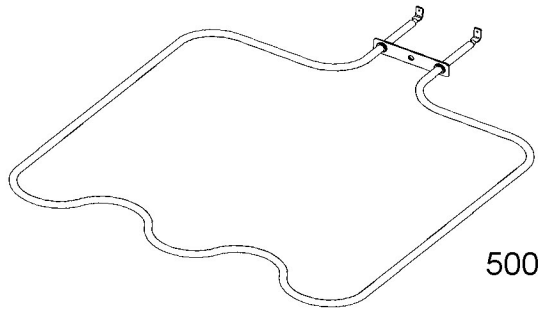

500B

