

35 4598

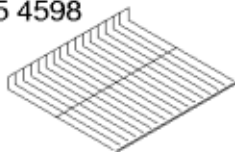

48 0527



49 3171



16 3401



2)
2)
2)
2)

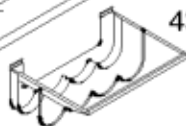

43 6162

43 9681



43 6589

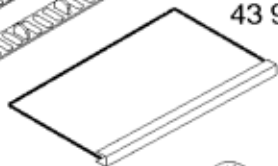

43 9682

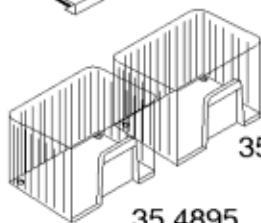

35 4895

35 4895

26 6492



26 6492



43 9788

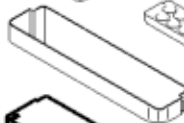

43 9730

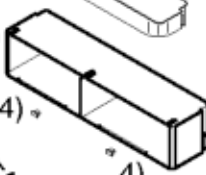

4)

4)

49 3918



5)

5)

49 3917



42 0012



43 9790



43 9792

43 3888



47 1124

47 1878

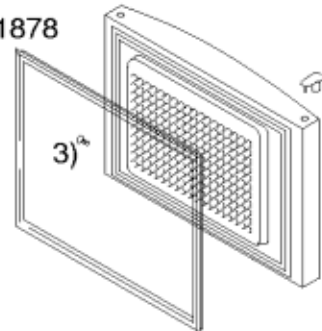

1)

3)

8)

7)

6)

6)

7)

24 1272

24 1887

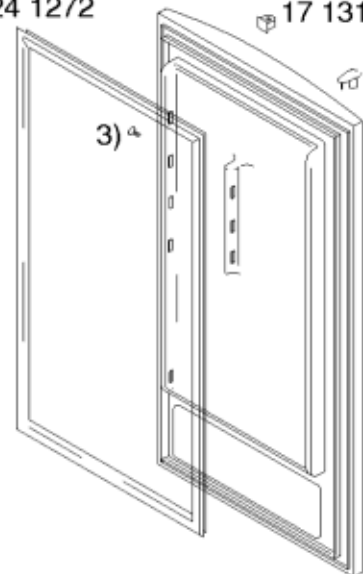

1)

3)

9)

17 1319

