

350

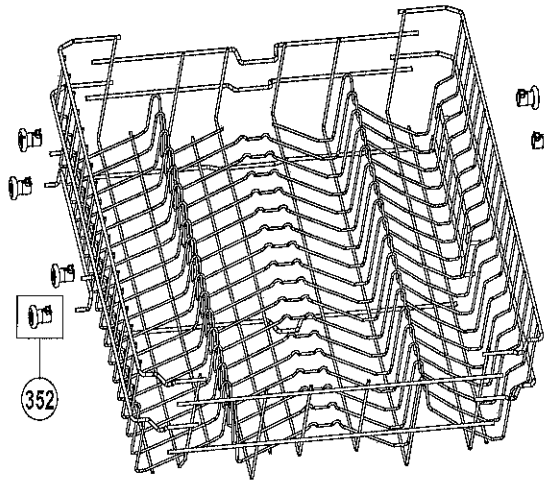

352

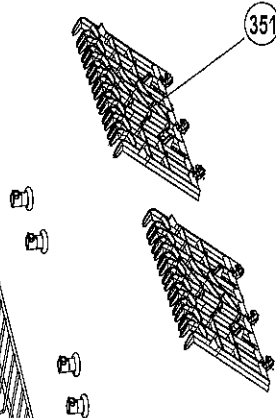

351

156

155

154

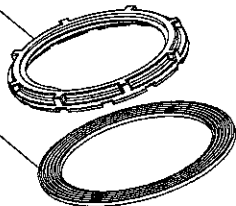

148

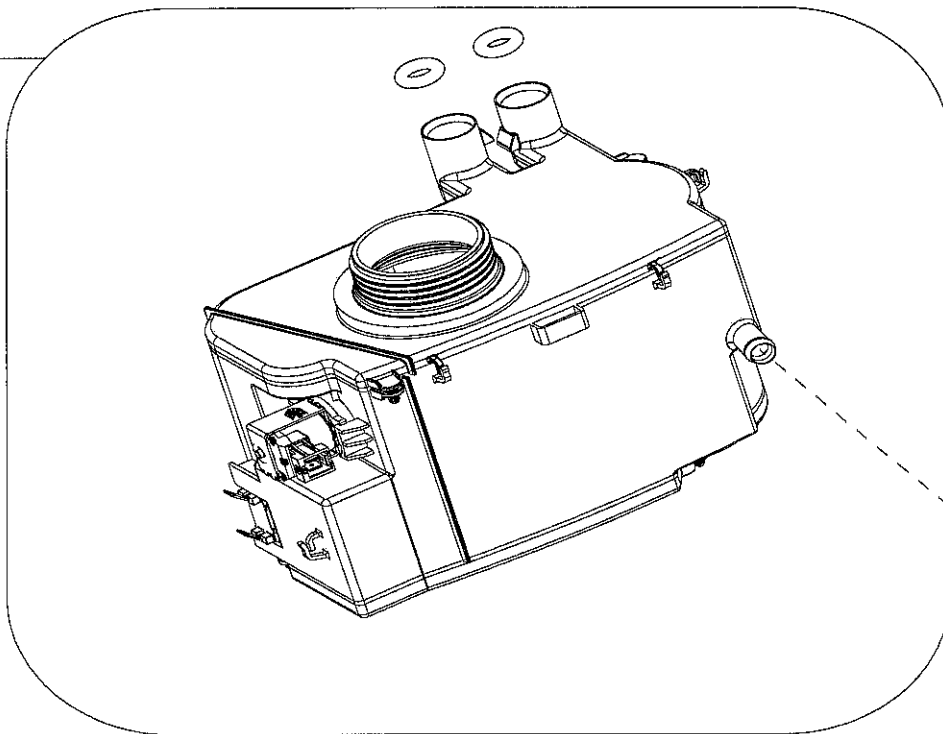

152

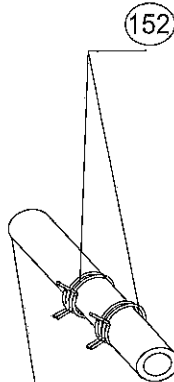

153

