

351

352

350

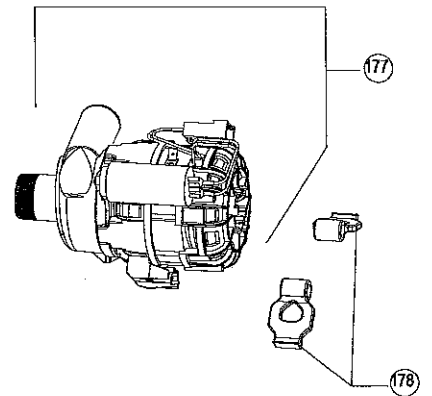

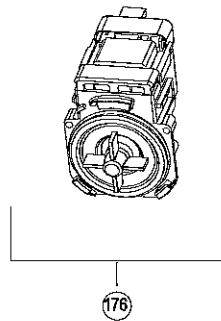
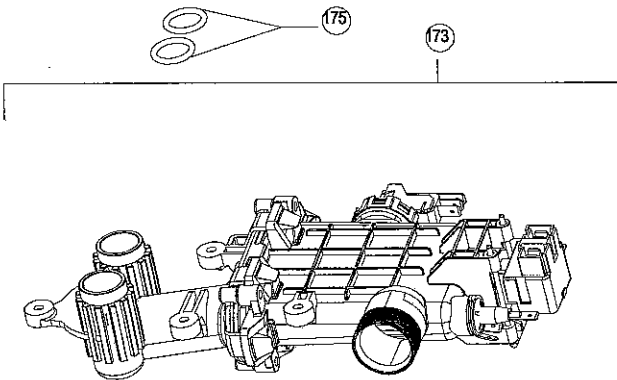
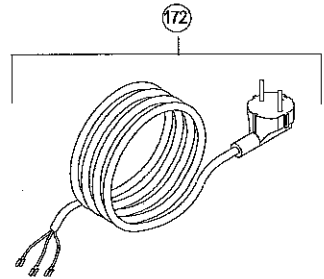
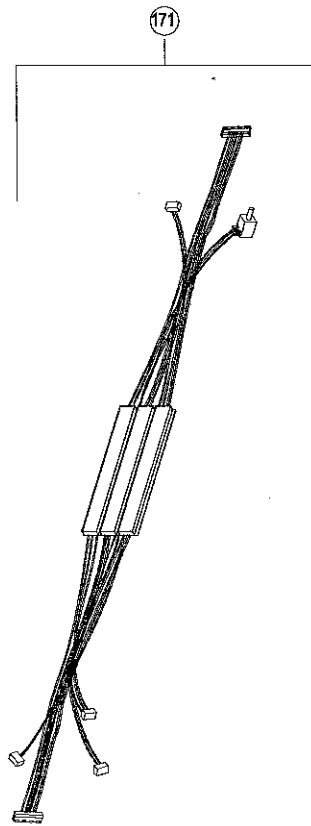
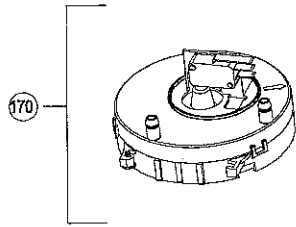

156

155

154

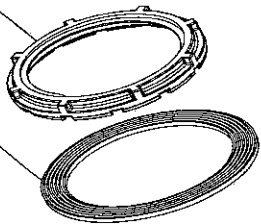

148

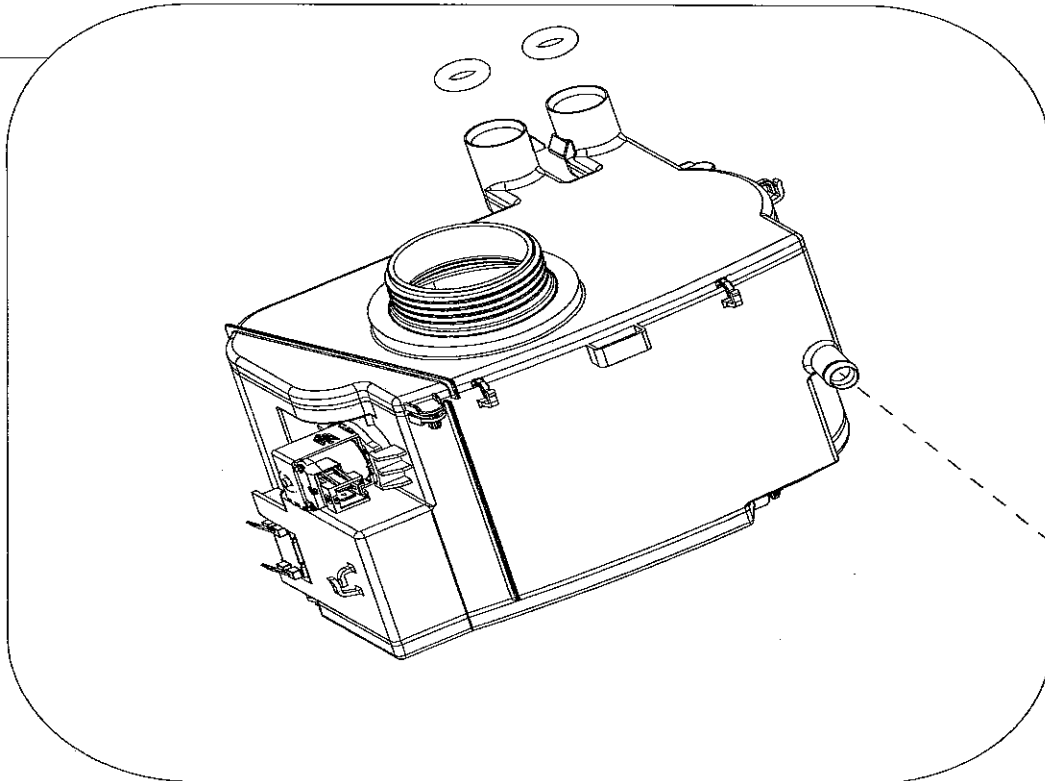

152

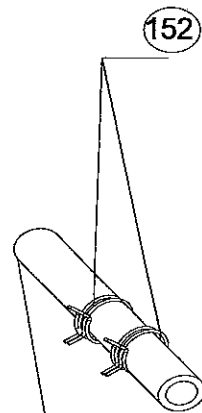

153

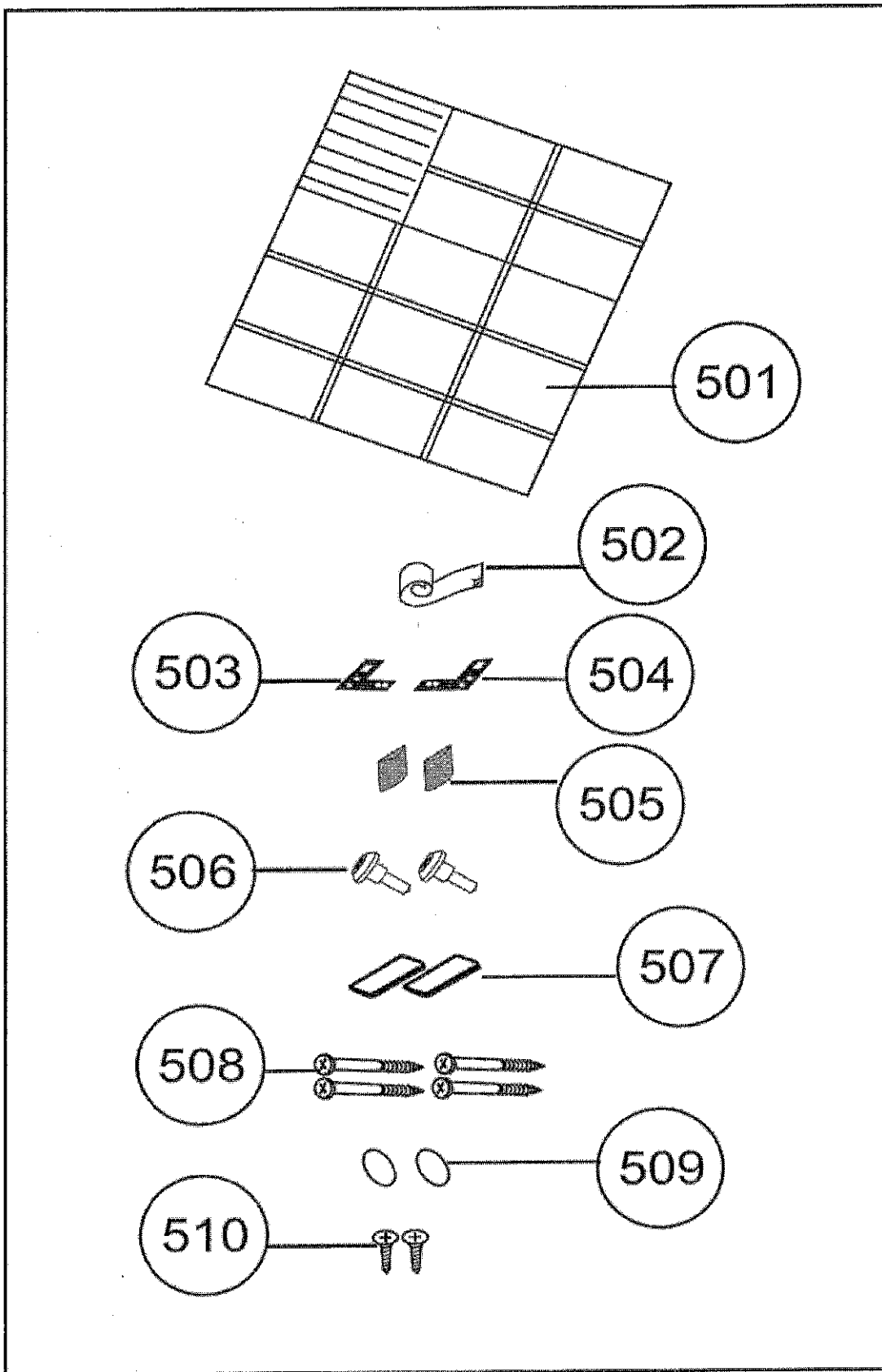

500

501

502

503

504

505

506

507

508

509

510

