

156



155



154

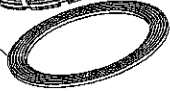

148

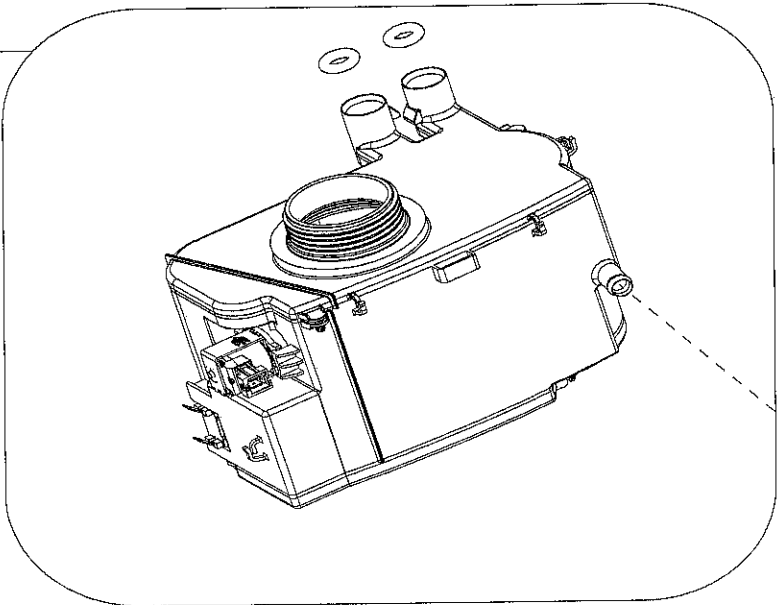

152

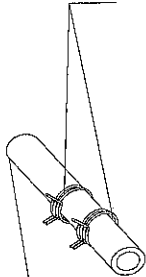

153



