

OPTIONAL
WITH TOP PANEL LED

735

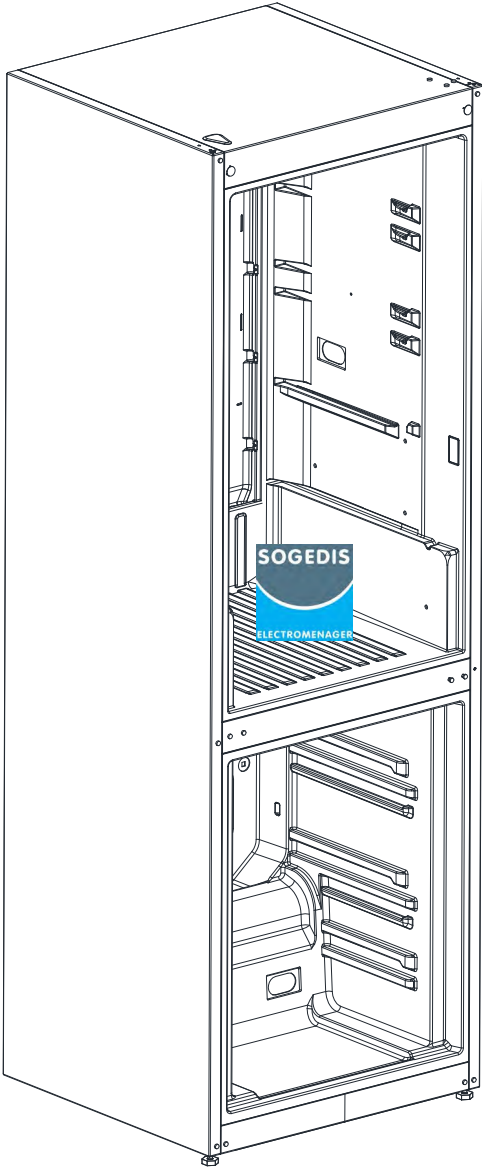
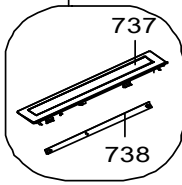

SOGEDIS
ELECTROMENAGER

OPTIONAL
WITH SIDE PANEL LED

421B

421A



428

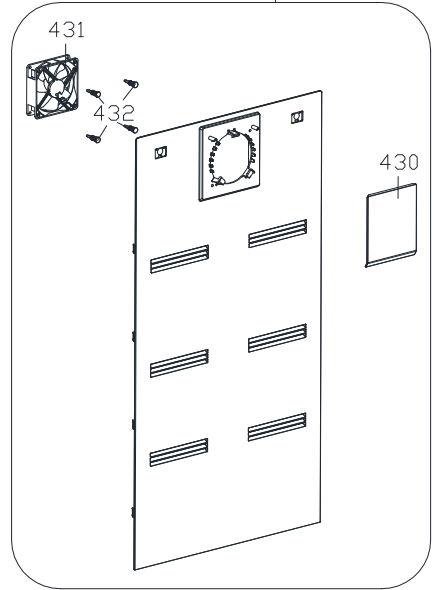

624 433B

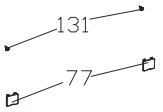

401

499

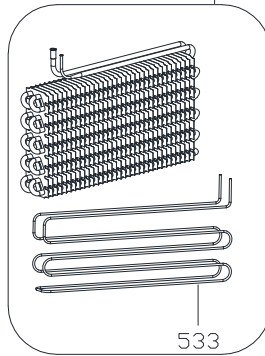

408

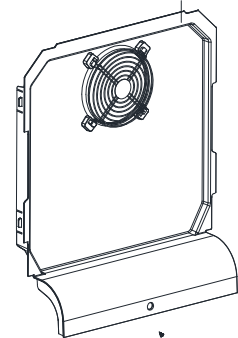

70

624



407

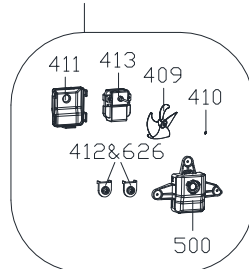

OU

431-B



**RADIAL FAN
DESIGN**

696

154

695

ELECTRONIC CONTROL

200

189

SOGEDIS
ELECTROMENAGER

460



175



175

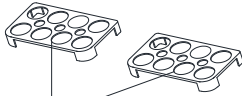

159

177

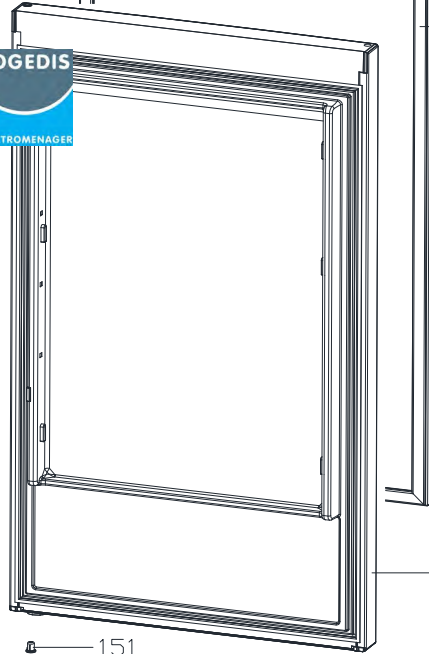

155

151

173

171

151

152

459

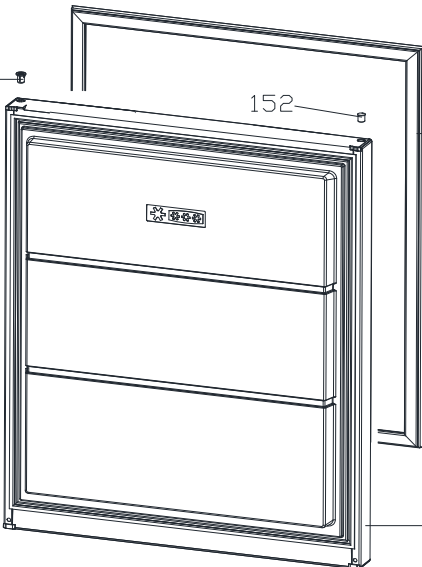

153

174B

187

174

510

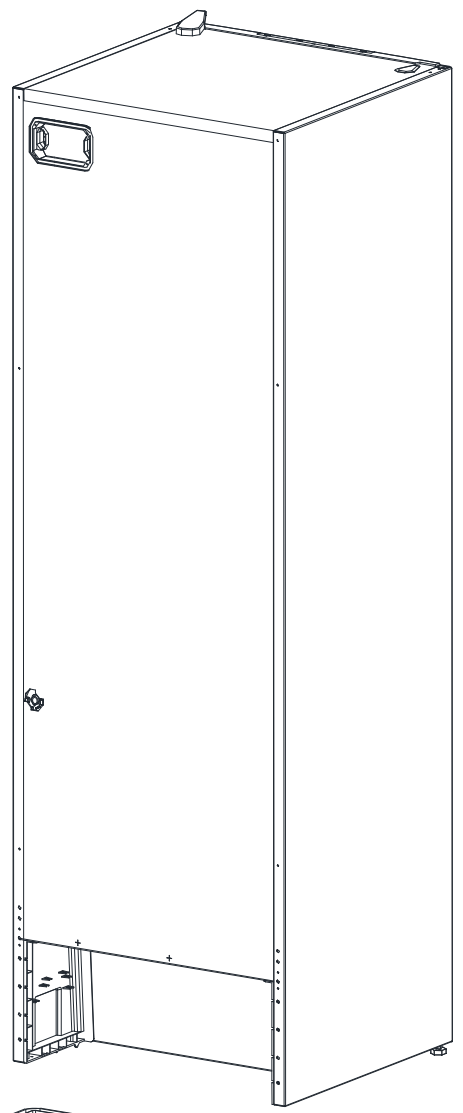
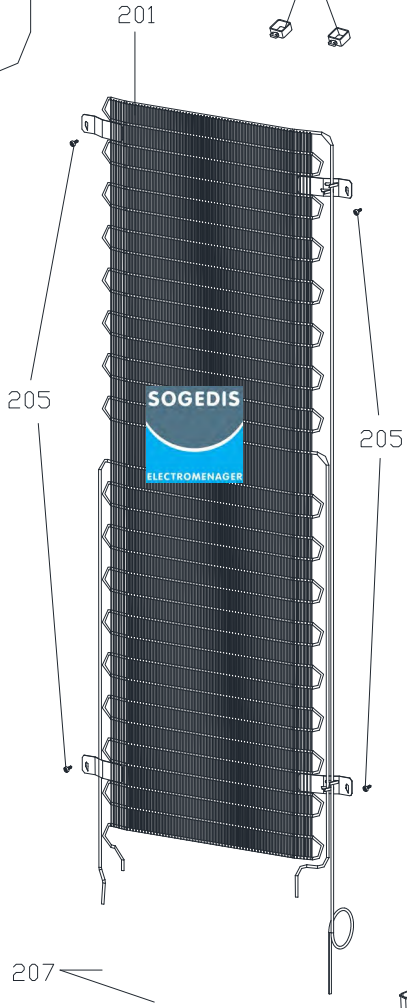
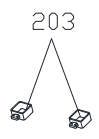
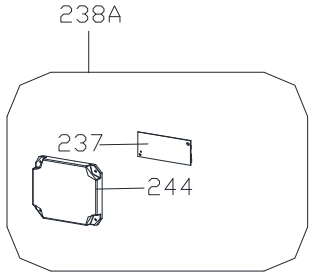

INVERTER
(OPTIONAL)

