

OPTIONAL

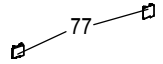

OPTIONAL

421 422

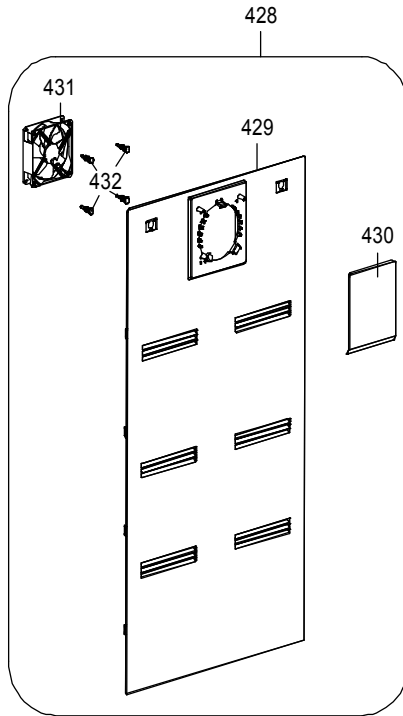
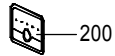
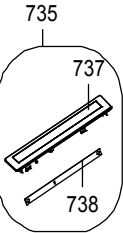
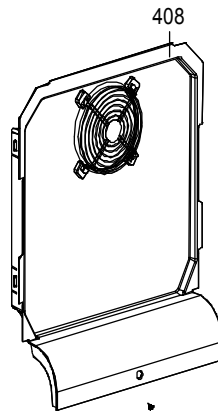
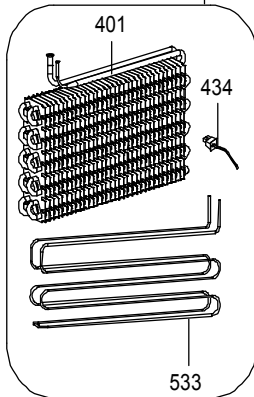

Version 230v

407

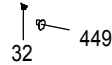
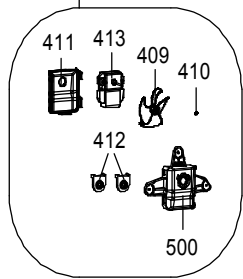

431-B

Version 12v



RADIAL FAN DESIGN

154

189

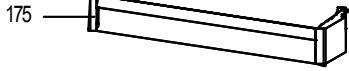
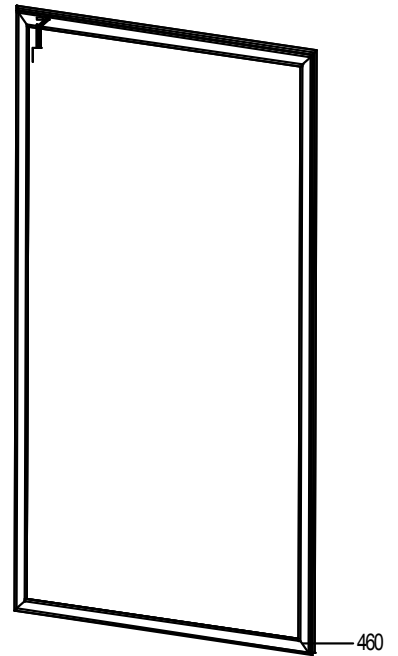
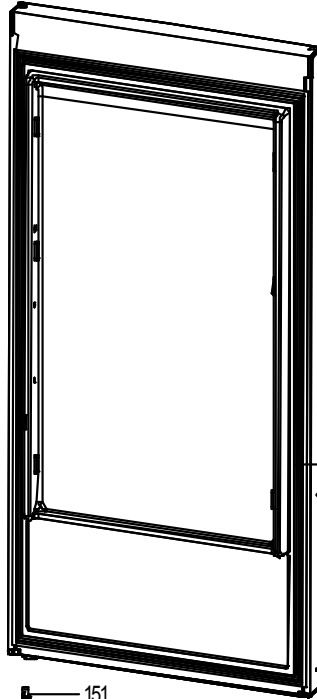

OPTIONAL

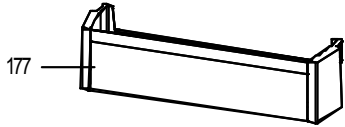
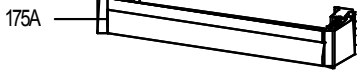

- 151
- 173
- 171

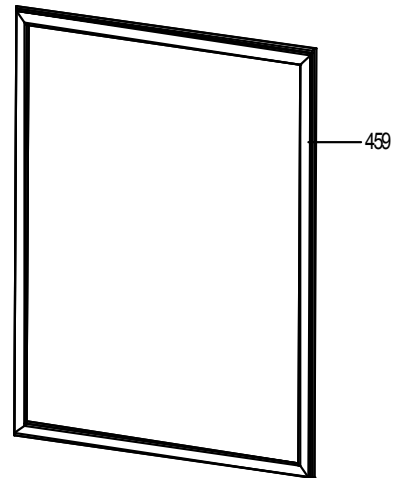
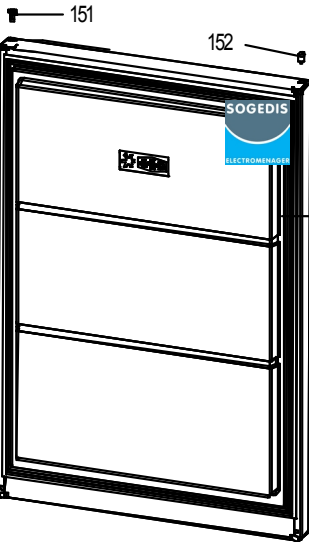

- 174B
- 187
- 174
- 463

