

# DIAGRAMME DE CONTACTS D' INVERSION DU PROGRAMMATEUR NP-14400-132 C

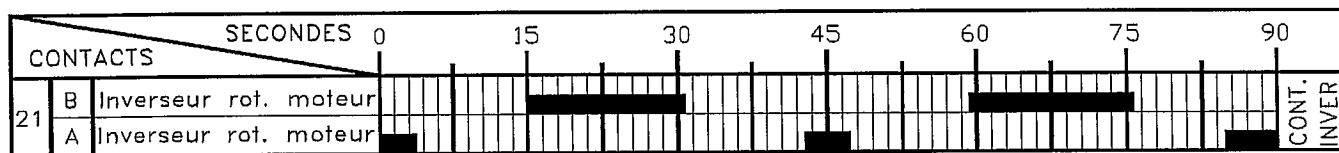

## SCHEMA ELECTRIQUE DU PROGRAMMATEUR NP-14400-132 C

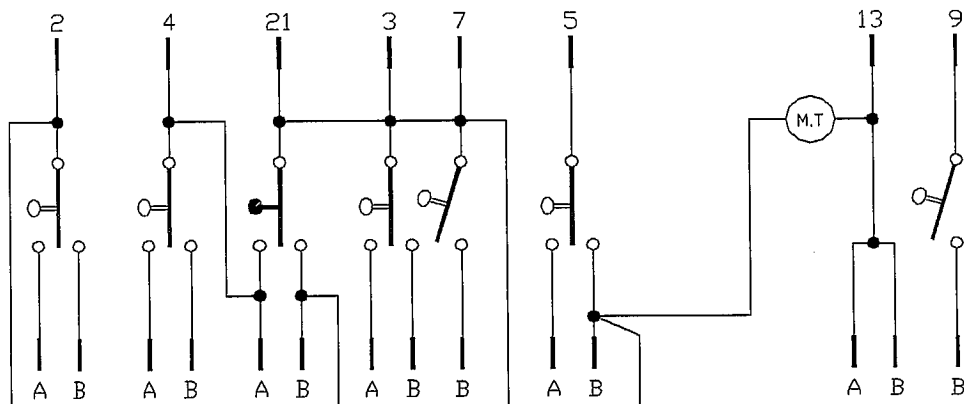

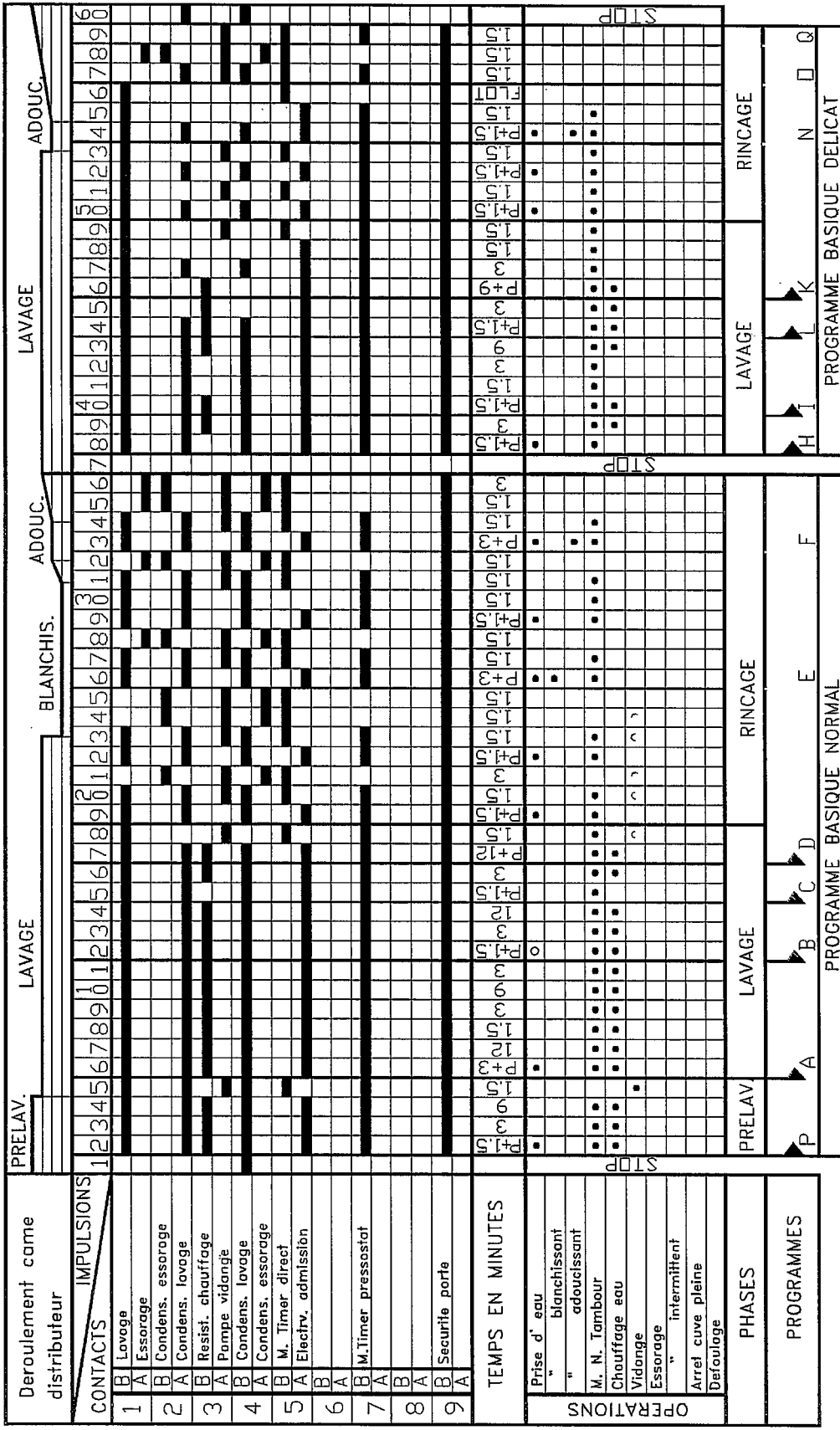

● Cette operation se realise chaque fois qu'apparait ce signe  
 ○ Cette operation se realise si le programme commence a cette impulsion

# SCHEMA ELECTRIQUE THEORIQUE 220 V.

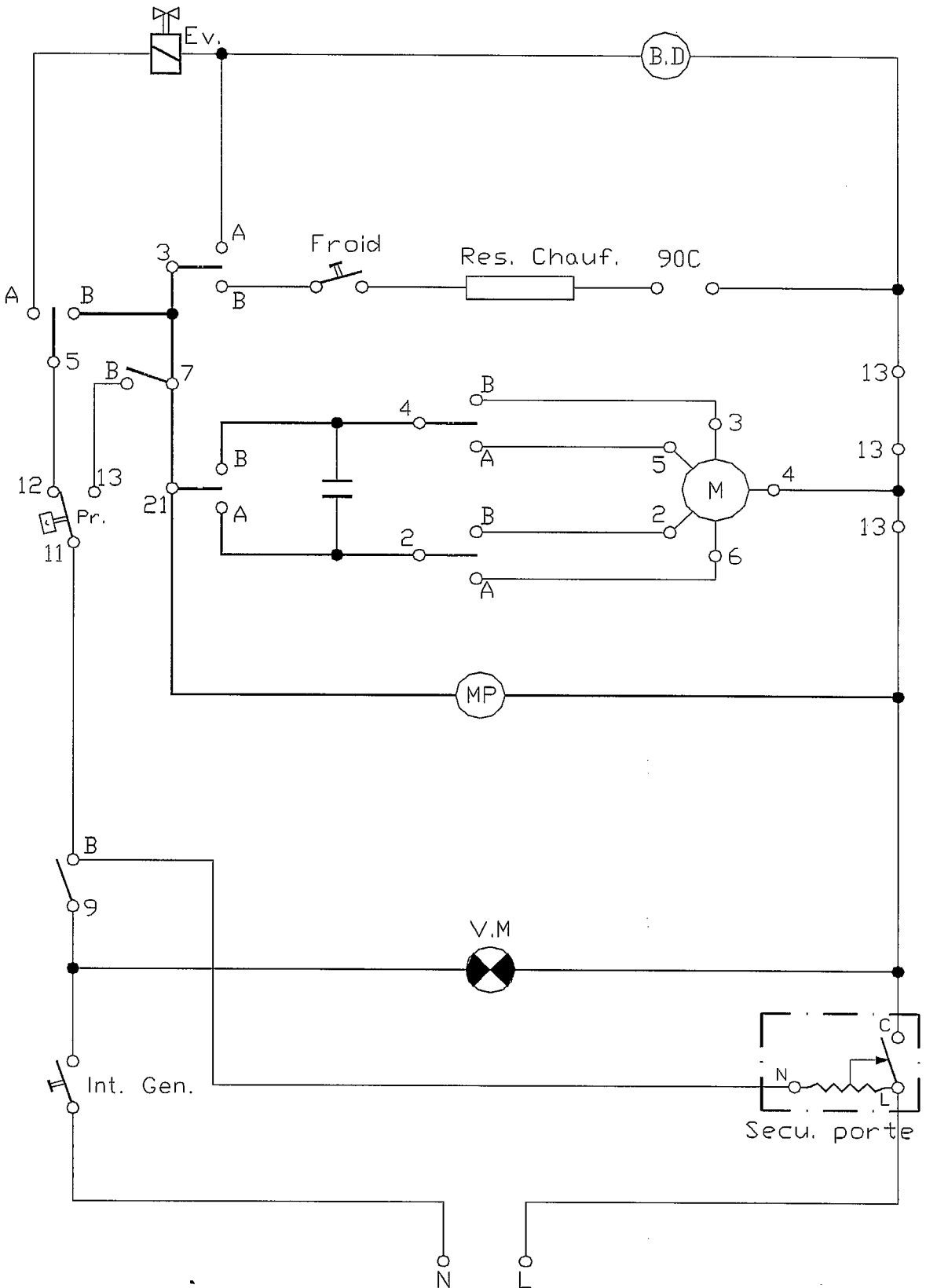

# SCHEMA DE CABLAGE A 220 V.

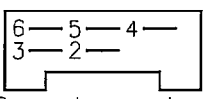
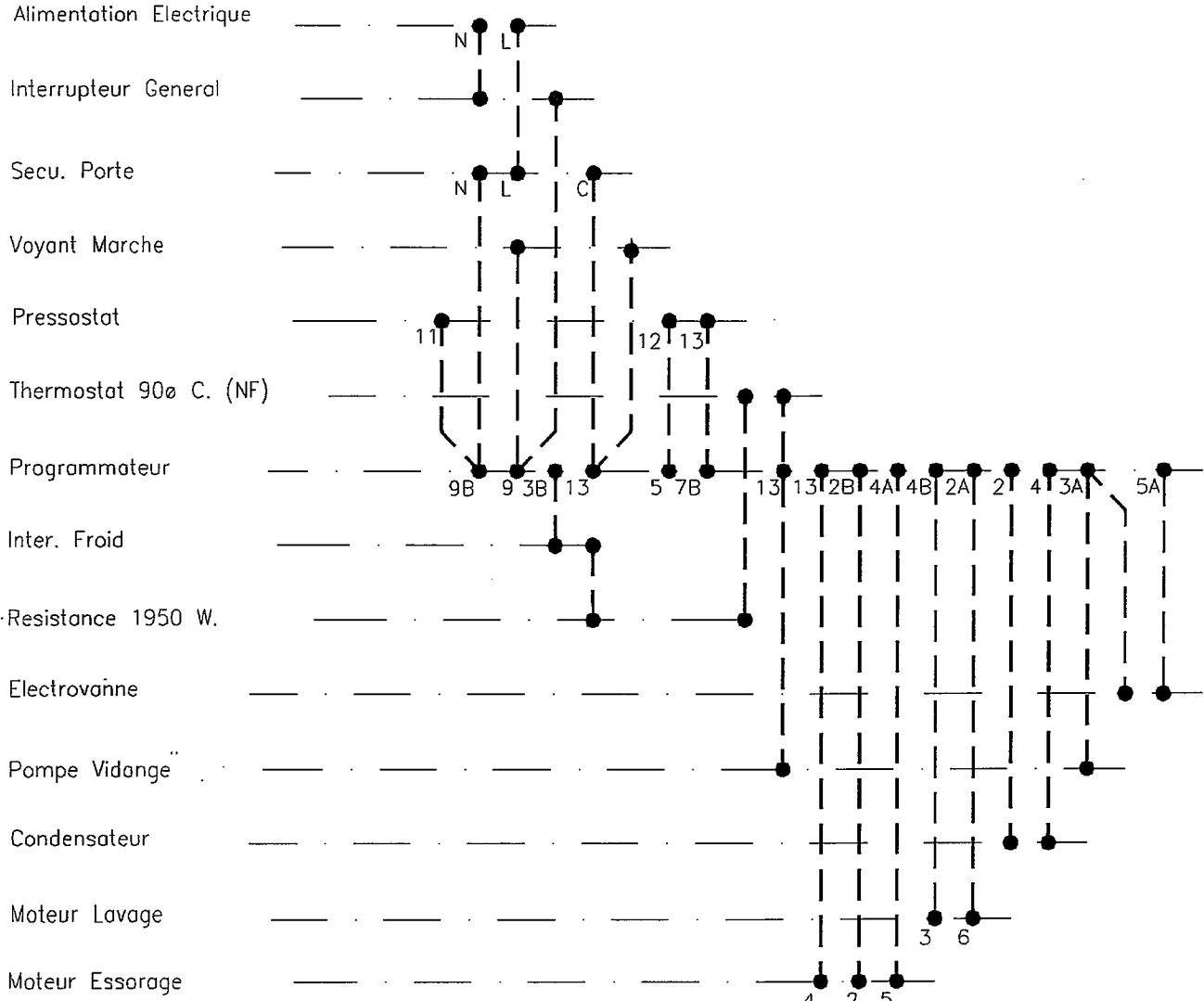

Connecteur moteur

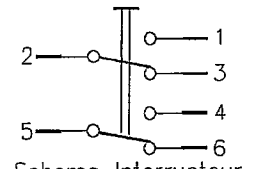

Schema Interrupteur